

# FIX Z PRO

INSTALLATION MANUAL V1.0

LAST REVISED ON 02.02.2024



## TABLE OF CONTENTS

1.0 Introduction .....	2
1.1 Short Description of the system.....	2
1.2 Scope of the Installation Manual.....	2
1.3 Appropriate Use/Warnings.....	2
1.4 Safety Instructions .....	3
2.0 System Overview.....	4
2.1 System Setup .....	4
2.2 Components Details .....	5
3.0 Installation Tools.....	9
4.0 Mounting Instructions .....	10
4.1 Tilt Frames .....	10
4.1.1 FixZ Pro Configurations.....	10
4.1.2 FixZ Pro Setup .....	11
4.1.3 Secure Fasteners to Roof.....	11
4.2 Rail Installation .....	12
4.2.1 Choice of rail .....	12
4.2.2 Add Rail Splice.....	12
4.2.3 FixZ Pro Rail + Elevation Element + Module Support Pro.....	13
4.3 Module Mounting .....	14
4.3.1 Position Modules .....	14
4.3.2 Secure Modules.....	14
4.4 Accessories .....	15
4.4.1 Micro-Inverter/Optimiser Kit Proline.....	15
4.4.2 Earthing Lug .....	15
4.4.3 Rail Cable Clip.....	16
5.0 Maintenance .....	17



## 1.0 Introduction

### 1.1 Short Description of the system

Schletter Australia offers a wide array of solutions for tilt mount photovoltaic (PV) applications suitable for nearly any environmental condition. The solar mounting systems are designed for strength and ease of installation using high-quality products to meet or exceed applicable local and international standards.

The system consists of fastening frames securing Proline rails which support PV modules. The pre-assembled components, slide-in rail joiners without the use of screws and click-in module clamps, account for ease of installation and industry leading installation times.

The components are made from Aluminium and High-Grade Steel allowing durability in adverse site conditions. The system comes with a 25-year warranty that is compliant with Australian Standards: AS/NZS 1170.2:2021 for wind actions, AS/NZS 1170.1:2002 (R2016) for imposed loadings, and AS/NZS 1170.0:2002 for general principles.

### 1.2 Scope of the Installation Manual

The manual aims to provide information on safety warnings, mounting system setup and components for the installation of PV modules in flat metal roofs.

Section 1 and 2 focuses on an introduction and an overall overview of the mounting system. Section 3 and 4 focuses on installation instructions on the appropriate methods for assembling the mounting system.

Please refer to the installation manual and bill of materials carefully before commencing any installation or maintenance work. All necessary information regarding installation and maintenance should be provided. For further questions, please contact Schletter Australia.

The content of this manual should be followed to comply with the product warranty.

### 1.3 Appropriate Use/Warnings

The mounting system acts as a support structure for the installation of photovoltaic modules. Any other and/or additional use or incorrect assembly (for example: use of third-party components) or non-observance of tolerance specifications are considered improper use and exclude any liability of the manufacturer. Any use under conditions other than those assumed in the planning is also considered improper use and leads to the loss of any liability claims against the manufacturer.

This applies if the system is used under other load, climatic and/or corrosion conditions than originally assumed. Schletter Australia is in no case responsible for damages to the product itself or consequential damages caused by the product which are the result of an inappropriate handling of the product.

Schletter Australia is not responsible for outages or faults resulting from modifications made by the customer or other individuals. There is no entitlement to the availability of previous versions or the re-fitting of delivered components to the current series status.

## 1.4 Safety Instructions

Read and understand these safety instructions carefully before starting the assembly and keep them safely at hand. Comply with all regional and national valid standards, building regulations and accident prevention regulations.



Break hazard! PV modules may be damaged if stepped on.



Planning, installation and commissioning of the solar power system must only be performed by qualified technical personnel. Improper execution can result in damage to the system and endanger individuals.



Electrical current hazard! Installation and maintenance of the PV modules must only be performed by qualified technical personnel. Observe the safety instructions issued by the PV module manufacturer!



Falling hazard! Working on the roof as well as ascending and descending poses a risk of falling. It is vital to observe accident prevention regulations and use appropriate fall protection equipment. PV mounting systems are not suitable as climbing aids or fall protection.



Injury hazard! Falling objects pose a risk of injury to people. Prior to installation, set up barriers in the hazard area to warn people nearby.



It is the obligation of the operator to ensure that all parts of the mounting instructions are kept within easy reach on the PV-plant for the fitters at any time.



As personnel, only persons who can be expected to carry out their work reliably can be admitted. Persons whose responsiveness is affected, e.g., by narcotics, alcohol, or medication, are NOT permitted.



## 2.0 System Overview

### 2.1 System Setup – FixZ Pro

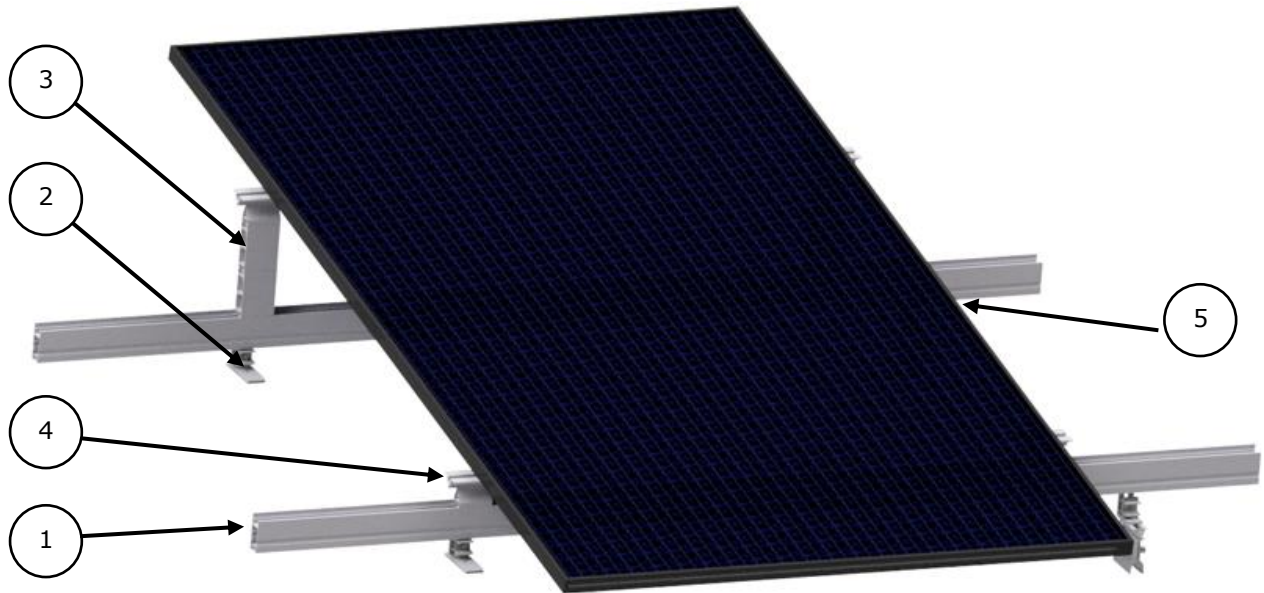

#### Key Components







- |                             |                              |                            |
|-----------------------------|------------------------------|----------------------------|
| <b>1</b> FixZ Pro Rail      | <b>2</b> Fastener            | <b>3</b> Elevation Element |
| <b>4</b> Module Support Pro | <b>5</b> Rail Joiner Proline |                            |

#### Accessories

- Module Cable Clips
- Optimiser Kit
- Earthing Lugs
- Earthing Shims



## 2.2 Components Details

ITEM CODE	ITEM DESCRIPTION	IMAGE	
120034-04400	FixZ Rail - 4400mm		RAILS
129200-000	Rail Joiner Proline		JOINERS
100001-002	Roof Hook Universal Proline		ROOF HOOKS
108000-000	Roof Hook Standard Proline		
119026-102	Rapid2+ Pro SML		TIN - DIRECT TO PURLIN
119026-902	Rapid2+ Pro SML Black		



111013-204 Corrugated EMU Proline



111013-204K Corrugated Klicktop Proline



113002-226 KingFix EMU Proline



113002-226K KingFix Klicktop Proline



113002-223 TrimFix EMU Proline

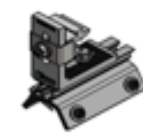

113002-223K TrimFix Klicktop Proline

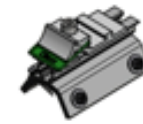

113009-003 SingleFix Pro











113011-000 Single Fix-HU

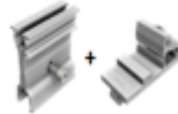
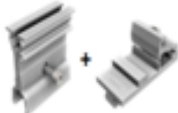

TIN - DIRECT TO SHEET



112012-117	KlipLok Classic EMU	
112012-127	KlipLok High Strength EMU	
112012-107C	KlipLok Classic Klicktop	
112012-107H	KlipLok High Strength Klicktop	
131020-001	Mid Clamp 30-47mm Proline	
131020-000	End Clamp 30-47mm Proline	
131020-901	Mid Clamp 30-47mm Proline Black	
131020-900	End Clamp 30-47mm Proline Black	
165005-004	Module Support Pro	
165005-003	Pro Heightening Element	

KLIPLOCK CLAMPS

MODULE CLAMPS

FixZ Pro



900000-065	Universal Screw, Purlin	
900000-360	Screw, Direct to Sheet	
129065-009	Module Cable Clip	
129065-001	Rail Cable Clip	
129200-010	Plastic End Cap Proline	
129200-910	Plastic End Cap Proline Black	
135003-002P	Earthing Clamp Proline	
135004-002P	Earthing Shim Proline	
149120-004P	Micro/Optimiser Kit Proline	

ACCESSORIES

ACCESSORIES

## 3.0 Installation Tools



**Tape Measure**



**Chalk Line**



**Marker**



**Pliers**



**Angle Grinder**



**Carpenter's Square**



**Rubber Mallet**



**Torque Wrench**

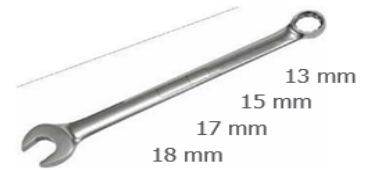

**Wrench**



**Rechargeable Power Drill**



**Torx® bit (TX 40)**



## 4.0 Mounting Instructions

### 4.1 Tilt Frames

#### 4.1.1 FixZ Pro Configurations

The FixZ Pro system can be oriented at  $5^\circ$ ,  $10^\circ$  and  $15^\circ$  for panels as shown in [Fig 4.1.1]. This is achieved by the use of elevation elements:

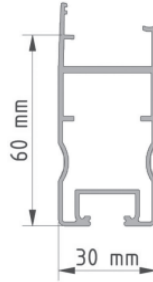

- $5^\circ$  Tilt – 1 Elevation Element

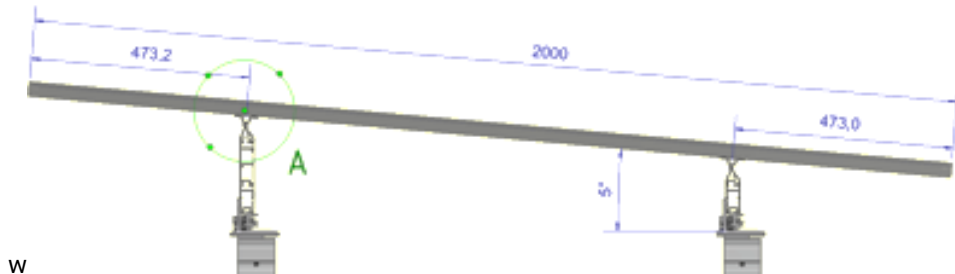

w

- $10^\circ$  Tilt – 2 Elevation Elements

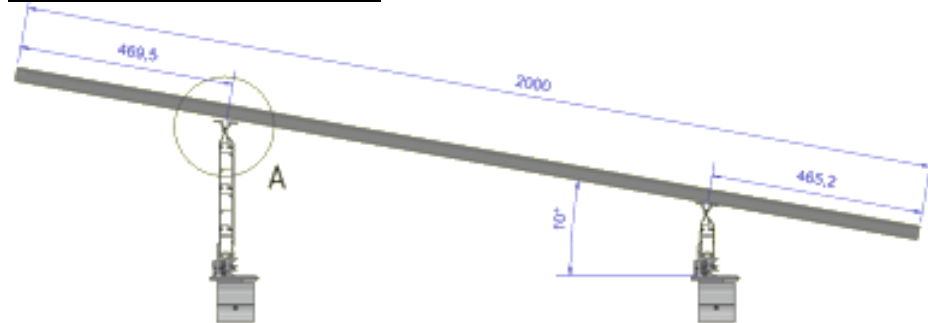

- $15^\circ$  Tilt – 3 Elevation Elements

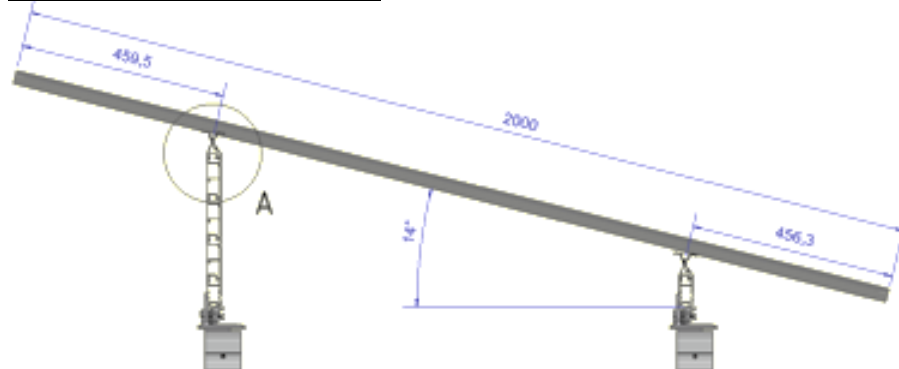

Fig 4.1.1 FixZ Pro at  $5^\circ$ ,  $10^\circ$  and  $15^\circ$  tilt orientation.



#### 4.1.2 FixZ Pro Setup

- I. The fasteners (Rapid<sup>2+</sup> Pro SMLs or Seam Clamps), based on the roofing sheet application, are positioned as per the installation plan. The variables **A**, **B** and **C** as per [Fig 4.1.2] need to be determined at the site before securing the FixZ Pro frames to the roof purlins.
- II. **A** determines the spacing between the fasteners to position the FixZ rails to achieve the required tilt as per [Fig 4.1.2].
- III. **B** is shading distance which can be determined from standard shading calculations.
- IV. **C** can be determined from standard engineering certificates.

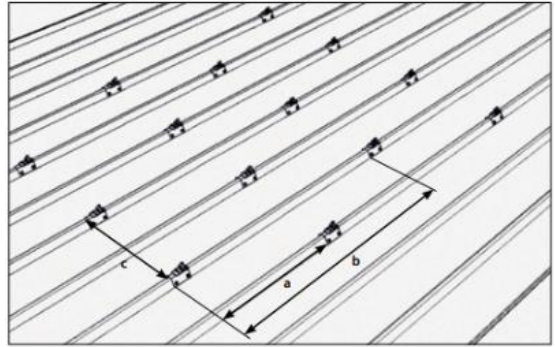

Fig 4.1.2: Screw fixing and shading distances

#### 4.1.3 Secure Fasteners to Roof

- I. The fasteners (Rapid<sup>2+</sup> Pro SMLs or Seam Clamps) are secured to the roof purlin via the supplied self-drilling universal screws, 6.2mm x 65mm. Ensure that the screw drilling line of the axis is perpendicular to the roofing sheet.

The universal screw works with both timber and steel substructures if the screw embedment requirements are met:

Substructure	Embedment (mm)
F7 Pine Softwood	36mm
1.5 BMT Steel	Complete Penetration - For steel purlins > 1.9mm, pre-drilled hole of 4.5mm in diameter is recommended

The tightening torque must be limited (15Nm) to prevent this deformation and to ensure thermal expansion is not impeded.

In case of applications of trapezoidal tin roofs with wooden purlins, we recommend using the 6.2mm x 80mm screws to reach minimum embedment of 36mm.

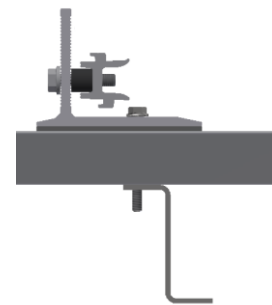

Fig 4.1.3: Rapid<sup>2+</sup> Pro SMLs being attached to using universal screw



## 4.2 Rail Installation

### 4.2.1 Choice of rail

The FixZ Pro rails come in standard sizes of 4400mm.

### 4.2.2 Add Rail Splice

- I. To increase the array length, rails can be spliced together using rail joiners [Fig 4.2.2A].
- II. Insert half of internal splice into first rail, push until it reaches midpoint where the stop tab is located under the splice [Fig 4.2.2B].
- III. Add the second rail to opposite end until it fully reaches the middle stop plate. This should lock both rails together forming a longer array [Fig 4.2.2C].

No screws are required, saving installation time.

 For FixZ Pro Rail, the maximum array length is 20m. However, we would recommend 20m for fixing to substructure and 11m for fixing in roofing sheets due to thermal expansion on roof sheet.

 The rail joiners are for single use application only.

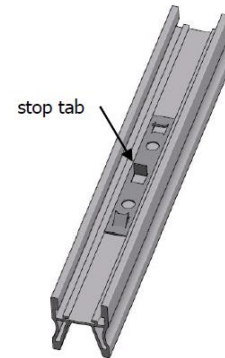

Fig 4.2.2A: Rail Joiner

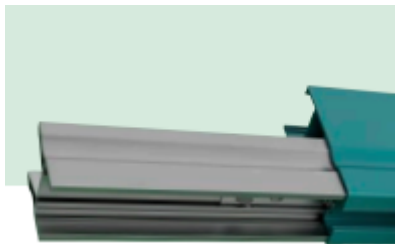

Fig 4.2.2B: Joiner connecting Proline rails



Fig 4.2.2C: Rails secured together via Proline joiner

## 4.2.3 FixZ Pro Rail + Elevation Element + Module Support Pro

- I. The FixZ rails are positioned by placing the square channel at the bottom of the rail on top of the multi-adapter.
- II. The higher side of the rail, **A**, should be facing down the slope of the roof for both the top and bottom rails.
- III. Secure the FixZ rail to the fasteners by tightening the M8 bolt using the recommended torque (15 Nm).
- IV. Add elevation elements to the rear FixZ Pro rails to enable panel tilt orientation of 5°, 10° and 15° as depicted in section 4.1.
- V. Add Module Support Pro to the front and rear legs after the desired tilt angle has been reached by the use of elevation element.
- VI. The Module Support Pro locks in using the same mechanism as the elevation elements

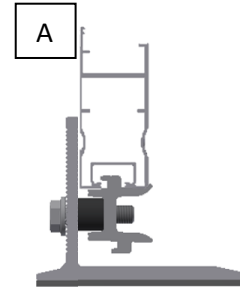

Fig 4.2.3A: FixZ Rail positioned to secure to fasteners

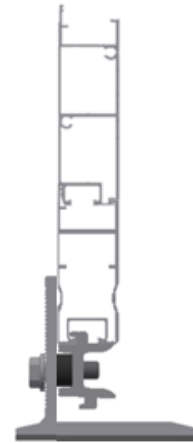

Fig 4.2.3B: Adding elevation element to FixZ Rail

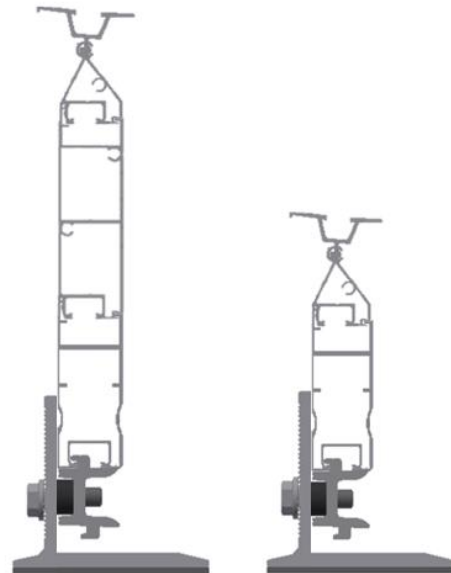

Fig 4.2.3C Module Support Pro on top of Rear (left) and Front (Right) Leg



### 4.3 Module Mounting

#### 4.3.1 Position Modules

- I. Position end clamps on rail approximately 20mm from end of rail, do not tighten [Fig 4.3.1].
- II. Position first module and secure using pre-positioned end clamps, do not tighten.
- III. Attach middle clamps to rail on the exposed side of the first module.
- IV. Place second module next to first module and secure using middle clamp, do not tighten.
- V. Repeat until end of row.

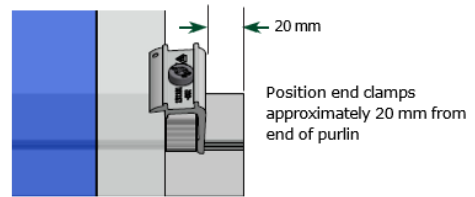

Fig 4.3.1: Positioning end clamp

#### 4.3.2 Secure Modules

- I. Verify that the module clamp is fully engaged on the rail and 1.5 mm maximum middle clamp to module offset is aligned with the module frame [Fig 4.3.2A].
- II. Secure all clamps [middle and end] to recommended torque settings [15Nm].

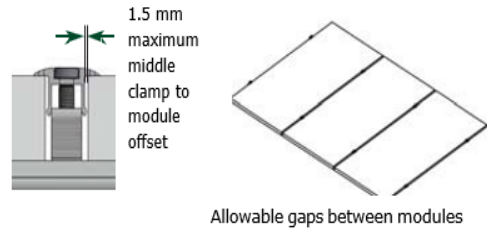

Fig 4.3.2A: Securing middle clamp and PV modules

When mounting modules, please observe the clamping points specified by the module manufacturers.

- III. Please observe a minimum of 5mm gap between module rows for better heat dissipation [Fig 4.3.2B].



Fig 4.3.2B: Gap between PV Module rows

## 4.4 Accessories

### 4.4.1 Micro-Inverter/Optimiser Kit Proline

The optimiser kits enable the mounting of optimisers and micro-inverters on top of Fix Z Pro rails:

- I. Add an additional Module Support Pro to either the top or bottom row of the PV array, as shown in [Fig 4.4.1].
- II. Loosely connect the bolts and washer to the mounting holes of the micro-inverter.
- III. The microinverter/optimiser can be positioned by top entry or sliding in top of the rail [V-channel] using the hammerhead nuts on top of the Module Support Pro, as shown by the left image in [Fig 4.4.1].
- IV. Secure the bolt using recommended torque settings [15Nm].

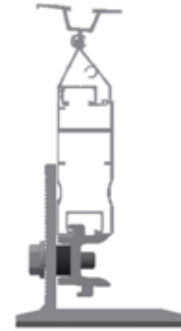

Fig 4.4.1: Optimiser Kit Installation

### 4.4.2 Earthing Lug

The earthing lug can be used as a potential equalization within the mounting racks.

- I. Add an additional Module Support Pro to either the top or bottom row of the PV array.
- II. The lug can be positioned by top entry or sliding in top of the rail [V-channel] of the Module Support Pro, anywhere on the rail channel.
- III. Place the earthing wires inside the lug chamber.
- IV. Secure the bolt using recommended torque settings [15Nm].
- V. Clamp distance to the edge: 8-10 mm<sup>2</sup>.
- VI. Connection (single/multi-wired): 4-50 mm<sup>2</sup>.
- VII. We recommend the use of one earthing lug per array, to ensure electrical continuity of the PV system.





### 4.4.3 Rail Cable Clip

The Proklip-Multi 10 allows quick rail cable clip installation without the use of any nuts and bolts.

- I. Position the clip (A) of the rail cable clip underneath the bottom (rectangular) channel (B) of the Proline rails.
- II. Insert cable clip by pushing firmly into the channel, until it snaps in, as shown in [Fig 4.4.3].

The cables are then run through the retainer and the clip can be closed by pressing it in.

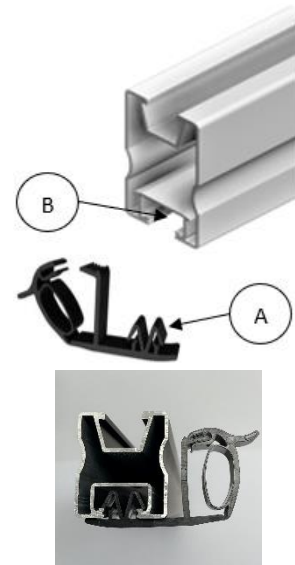

Fig 4.4.3: Rail cable clip attached to Proline rail

### 4.5 Torque Specifications and Tolerances

The various bolt sizes of the mounting system and their recommended torques in the mounting system is listed in Table 4.5:

Bolt Size	Recommended Torques
Torx Bolt for RapidPro Module Clamps	15 N-M
M6 and 1/4" Bolt	6 N-M
M8 and 5/16" Bolt	15 N-M
M10 and 3/8" Bolt	40 N-M
M12 and 1/2" Bolt	70 N-M

**Note:** Recommended speed for installation of self-drilling 1/4" diameter is 1200-1800 RPMS

Table 4.5: Size of bolt and recommended torques

For project specific system design, please refer to project specific drawings for recommended torque for each size of bolt used in the system and allowable tolerances. In the event of deviation from approved drawings, contact Schletter Australia immediately.



## 5.0 Maintenance

In general, once correctly assembled, the roof-top systems should operate reliably with minimal maintenance. However, Schletter Australia recommends yearly inspection of system should be conducted to maintain optimal performance. This ensures the system’s long-term durability and reliability.

The following best practises and inspection guidelines are advised for roof-top mounting systems:

- I. Prior to installation, it is advisable to store products free from contamination by contact with items that may contain rust, dirt and chemicals. If contamination occurs, affected products has to be cleaned using appropriate methods such as using galvanised zinc spray on affected areas.
- II. Clean any visible contamination from soil, and other particles.  
Further guidelines on this can be found in:

Standards	Material	Country
Standards Association of Australia	Aluminium	Australia
Galvanizers Association of Australia (GAA)	Steel	Australia
Galvanizers Association of New Zealand (GANZ)	Steel	New Zealand

- III. Visually inspect for signs of damage, wear, corrosion, or movement.  
Replace any affected components immediately.



Aluminium components may undergo surface oxidation, forming a thin and hard film of Aluminium oxide which looks like powdery white or dull grey finish. This is standard ageing process for Aluminium and is beneficial for long-term durability of the product. The oxide layer acts as a barrier against atmospheric corrosion.

- IV. Check torque values of fastening bolts in the structure as per recommended torques in section 6.5.  
The following inspection process can be followed:
  - a) At least 2% of bolted connections must be checked using a calibrated torque wrench. The torque wrench must have a display or be a click type torque wrench.
  - b) Torque wrench should be set at 50% of intended tightening torque.  
Check is successful if bolt cannot be loosened.
  - c) If more than 10% of checked bolted connections are loose, a re-check has to be done.  
The re-check should be increased to 10% of all bolted connections.
  - d) If more than 10% of connections are still loose, all bolted connections much be checked.
  - e) Tighten all non-conforming bolts to specified torques as per section 6.5.
- V. Check for loose wiring.

The maintenance guidelines above apply only to the components of the mounting structure that are manufactured from Schletter. For external components, maintenance should be carried out respective to relevant manufacturer’s guidelines.



**SCHLETTER SOLAR GMBH  
UNIT 4, 27 WILLIAMSON ROAD  
2565 INGLEBURN  
AUSTRALIA**

**P: (02) 9426 7800**

**[WWW.SCHLETTER-GROUP.COM](http://WWW.SCHLETTER-GROUP.COM)**

*We reserve the right to changes, including technical modification.*