

User Manual

1-phase Hybrid Inverter

SH3.0RS/SH3.6RS/SH4.0RS/SH5.0RS/SH6.0RS



All Rights Reserved

All Rights Reserved

No part of this document can be reproduced in any form or by any means without the prior written permission of Sungrow Power Supply Co., Ltd (hereinafter "SUNGROW").

Trademarks

SUNGROW and other Sungrow trademarks used in this manual are owned by SUNGROW.

All other trademarks or registered trademarks mentioned in this manual are owned by their respective owners.

Software Licenses

- It is prohibited to use data contained in firmware or software developed by SUNGROW, in part or in full, for commercial purposes by any means.
- It is prohibited to perform reverse engineering, cracking, or any other operations that compromise the original program design of the software developed by SUNGROW.

About This Manual

The manual mainly contains the product information, as well as guidelines for installation, operation, and maintenance. The manual does not include complete information about the photovoltaic (PV) system. Readers can get additional information at www.sungrowpower.com or on the webpage of the respective component manufacturer.

Validity

This manual is valid for the following model of low-power grid-connected PV string inverters:

- SH3.0RS
- SH3.6RS
- SH4.0RS
- SH5.0RS
- SH6.0RS

It will be referred to as "inverter" hereinafter unless otherwise specified.

Target Group

This manual is intended for professional technicians who are responsible for installation, operation, and maintenance of inverters, and users who need to check inverter parameters.

The inverter must only be installed by professional technicians. The professional technician is required to meet the following requirements:

- Know electronic, electrical wiring and mechanical expertise, and be familiar with electrical and mechanical schematics.
- Have received professional training related to the installation and commissioning of electrical equipment.
- Be able to quickly respond to hazards or emergencies that occur during installation and commissioning.
- Be familiar with local standards and relevant safety regulations of electrical systems.
- Read this manual thoroughly and understand the safety instructions related to operations.

How to Use This Manual

Please read this manual carefully before using the product and keep it properly at a place for easy access.

All contents, pictures, marks, and symbols in this manual are owned by SUNGROW. No part of this document may be reprinted by the non-internal staff of SUNGROW without written authorization.

Contents of this manual may be periodically updated or revised, and the actual product purchased shall prevail. Users can obtain the latest manual from support.sungrowpower.com or sales channels.

Security Declaration

For details on the product's network security vulnerability response process and vulnerability disclosure, please visit the following website: <https://en.sungrowpower.com/security-vulnerability-management>.

For more information on network security, please refer to the user manual of the communication module or the Data Logger that comes with the product.

Symbols

This manual contains important safety instructions, which are highlighted with the following symbols, to ensure personal and property safety during usage, or to help optimize the product performance in an efficient way.

Please carefully understand the meaning of these warning symbols to better use the manual.

DANGER

Indicates high-risk potential hazards that, if not avoided, may lead to death or serious injury.

WARNING

Indicates moderate-risk potential hazards that, if not avoided, may lead to death or serious injury.

CAUTION

Indicates low-risk potential hazards that, if not avoided, may lead to minor or moderate injury.

NOTICE

Indicates potential risks that, if not avoided, may lead to device malfunctions or financial losses.



“NOTE” indicates additional information, emphasized contents or tips that may be helpful, e.g., to help you solve problems or save time.

Contents

All Rights Reserved	I
About This Manual	II
1 Safety Instructions	1
1.1 Unpacking and Inspection	2
1.2 Installation Safety	3
1.3 Electrical Connection Safety	3
1.4 Operation Safety	6
1.5 Maintenance Safety	6
1.6 Disposal Safety	8
2 Product Description	9
2.1 System Introduction	9
2.2 Product Introduction	10
2.3 Symbols on the Product	11
2.4 LED Panel	12
2.5 DC Switch	13
2.6 PV Energy Storage System (PV ESS)	14
2.6.1 PV Energy Storage System (PV ESS)	14
2.6.2 PV Storage and EV Charging System	15
2.6.3 Declaration For Backup Function	16
2.7 Retrofitting the Existing PV System	16
3 Function Description	19
3.1 Safety Function	19
3.1.1 Protection	19
3.1.2 Earth Fault Alarm	19
3.2 Energy Conversion and Management	19
3.2.1 Power Derating	19
3.2.2 DRM ("AU"/"NZ")	20
3.2.3 Regular Operational Voltage Range	20
3.2.4 Regular Operational Frequency Range	20
3.2.5 Reactive Power Regulation	21
3.3 Battery Management	21

3.3.1 Charge Management.....	22
3.3.2 Discharge Management.....	23
3.4 EV Charger Management.....	24
3.5 PID Recovery Function	24
3.6 Communication and Configuration	25
3.7 Import Power Limit Function	25
3.8 Optimizer Functions.....	25
4 Unpacking and Storage	26
4.1 Unpacking and Inspection	26
4.2 Scope of Delivery	27
4.3 Inverter Storage	28
5 Mechanical Mounting	29
5.1 Safety During Mounting.....	29
5.2 Location Requirements	30
5.2.1 Installation Environment Requirements.....	30
5.2.2 Carrier Requirements	31
5.2.3 Angle Requirements.....	31
5.2.4 Clearance Requirements	32
5.3 Installation Tools.....	33
5.4 Moving the Inverter	34
5.5 Installing Mounting-bracket.....	35
5.6 Installing the Inverter.....	36
5.7 Installing Optimizer(Optional)	37
6 Electrical Connection	39
6.1 Safety Instructions	39
6.2 Terminal Description	41
6.3 Electrical Connection Overview	42
6.4 Backup Wiring Diagram	44
6.5 External Protective Grounding Connection	47
6.5.1 External Protective Grounding Requirements.....	48
6.5.2 Connection Procedure.....	48
6.6 AC Cable Connection	49
6.6.1 AC Side Requirements	49
6.6.2 Connecting the AC Cable	50
6.7 DC Cable Connection	53
6.7.1 PV Input Configuration	54

6.7.2 Assembling the PV Connectors	55
6.7.3 Installing PV Connector	56
6.8 Emergency Load Connection (Backup)	60
6.9 Battery Connection	63
6.9.1 Connecting the Power Cable	64
6.9.2 Connecting the CAN Cable	67
6.9.3 Connecting the Enable Cable	68
6.10 WiNet-S Connection	68
6.10.1 Ethernet Communication	68
6.10.2 WLAN Communication	70
6.11 Meter Connection	71
6.12 RS485 Connection.....	74
6.13 DRM Connection	75
6.14 EV Charger Communication Connection	78
6.15 Protective Cover Installation (Optional).....	79
7 Commissioning	82
7.1 Inspection Before Commissioning	82
7.2 Powering on the System	82
7.3 App Preparation	83
7.4 Plant Creation	83
8 iSolarCloud App	92
8.1 Brief Introduction	92
8.2 Installing App	92
8.3 Account Registration.....	93
8.4 Login	94
8.4.1 Requirements	94
8.4.2 Login Procedure	94
8.5 Initial Settings.....	96
8.5.1 Feed-in Limitation	96
8.5.2 Backup Mode.....	96
8.6 Function Overview	97
8.7 Home	97
8.8 Run Information.....	98
8.9 Records	99
8.9.1 Chart.....	99
8.9.2 Fault Alarm Record	100
8.9.3 Event Record.....	101

8.10 EV Charger (Optional).....	102
8.10.1 Driving Distance Per kWh	103
8.10.2 Charging Mode	103
8.10.3 Parameter Setting	108
8.10.4 Start/Stop Switch	109
8.11 More	110
8.11.1 System Parameters	111
8.11.2 Running Time.....	112
8.11.3 Regular Parameters	112
8.11.4 Off-grid Parameters	113
8.11.5 Active Power Regulation	113
8.11.6 Reactive Power Regulation	114
8.11.7 Battery Discharge Time.....	117
8.11.8 Battery Forced Charge Time.....	118
8.11.9 Communication Parameters	119
8.11.10 Firmware Update	119
8.11.11 Grounding Detection	120
8.11.12 Frequency Shift Power Control	121
8.11.13 Import Power Limit.....	122
9 System Decommissioning	123
9.1 Decommissioning the Inverter	123
9.1.1 Disconnect the Inverter.....	123
9.1.2 Dismantling the Inverter.....	123
9.1.3 Disposal of Inverter	124
9.2 Decommissioning the Battery	124
10 Troubleshooting and Maintenance	125
10.1 Troubleshooting.....	125
10.2 Maintenance	134
10.2.1 Maintenance Notices	134
10.2.2 Quick Shutdown.....	136
10.2.3 Routine Maintenance.....	136
11 Appendix	137
11.1 Technical Data	137
11.2 Quality Assurance.....	142
11.3 Contact Information.....	143

1 Safety Instructions

When installing, commissioning, operating, and maintaining the product, strictly observe the labels on the product and the safety requirements in the manual. Incorrect operation or work may cause:

- Injury or death to the operator or a third party.
- Damage to the product and other properties.

WARNING

- **Do not perform any operation on the product (including but not limited to, handling, installing, powering on, or maintaining the product, performing electrical connection, and working at heights) in harsh weather conditions, such as thunder and lightning, rain, snow, and Level 6 or stronger winds. SUNGROW shall not be held liable for any damage to the device due to force majeure, such as earthquakes, floods, volcanic eruptions, mudslides, lightning strikes, fires, wars, armed conflicts, typhoons, hurricanes, tornadoes, and other extreme weathers.**
- **In case of fire, evacuate from the building or product area and call the fire alarm. Re-entry into the burning area is strictly prohibited under any circumstances.**

NOTICE

- **Tighten the screws with the specified torque using tools when fastening the product and terminals. Otherwise, the product may be damaged. And the damage caused is not covered by the warranty.**
- **Learn how to use tools correctly before using them to avoid hurting people or damaging the device.**
- **Maintain the device with sufficient knowledge of this manual and use proper tools.**



- The safety instructions in this manual are only supplements and cannot cover all the precautions that should be followed. Perform operations considering actual onsite conditions.
- SUNGROW shall not be held liable for any damage caused by violation of general safety operation requirements, general safety standards, or any safety instruction in this manual.
- When installing, operating, and maintaining the product, comply with local laws and regulations. The safety precautions in this manual are only supplements to local laws and regulations.
- During the product transport, installation, wiring, maintenance, etc., the materials and tools prepared by users must meet the requirements of applicable local laws and regulations, safety standards, and other specifications. SUNGROW shall not be held liable for any damage to the product caused by the adoption of materials and tools that fail to meet the above-mentioned requirements.
- Operations on the product, including but not limited to, handling, installing, wiring, powering on, maintenance, and use of the product, must not be performed by unqualified personnel. SUNGROW shall not be held liable for any damage to the product resulting from operations done by unqualified personnel.
- Where the transport of the product is arranged by users, SUNGROW shall not be held liable for any damage to the product that is caused by users themselves or the third-party transport service providers designated by the users.
- SUNGROW shall not be held liable for any damage to the product caused by the negligence, intent, fault, improper operation, and other behaviors of users or third-party organizations.
- SUNGROW shall not be held liable for any damage to the product arising from reasons unrelated to SUNGROW.

1.1 Unpacking and Inspection

WARNING

Check all safety signs, warning labels and nameplates on devices.

Ensure that the safety signs, warning labels and nameplates must be clearly visible and cannot be removed or covered before the device is decommissioned.

NOTICE

After receiving the product, check whether the appearance and structural parts of the device are damaged, and check whether the packing list is consistent with the actual ordered product. If there are problems with the above inspection items, do not install the device and contact your distributor first. If the problem persists, contact SUNGROW in time.

1.2 Installation Safety

DANGER

- Make sure there is no electrical connection before installation.
- Before drilling, avoid the water and electricity wiring in the wall.

CAUTION

Improper installation may cause personal injury!

- If the product supports hoisting transport and is hoisted by hoisting tools, no one is allowed to stay under the product.
- When moving the product, be aware of the product weight and keep the balance to prevent it from tilting or falling.

NOTICE

Before operating the product, must check and ensure that tools to be used have been maintained regularly.

1.3 Electrical Connection Safety

DANGER

Before electrical connections, please make sure that the inverter is not damaged, otherwise it may cause danger!

Before electrical connections, please make sure that the inverter switch and all switches connected to the inverter are set to "OFF", otherwise electric shock may occur!

DANGER

The PV string will generate lethal high voltage when exposed to sunlight.

- Operators must wear proper personal protective equipment during electrical connections.
- Must ensure that cables are voltage-free with a measuring instrument before touching DC cables.
- Respect all safety instructions listed in relevant documents about PV strings.

⚠ DANGER

Danger to life due to a high voltage inside the inverter!

- Be sure to use special insulation tools during cable connections.
- Note and observe the warning labels on the product, and perform operations strictly following the safety instructions.
- Respect all safety instructions listed in this manual and other pertinent documents.

⚠ DANGER

If the battery is short-circuited, the instantaneous current will be excessively high and a large amount of energy will be released, which may cause fire and personal injury.

Disconnect the battery from all voltage sources prior to performing any work on the battery.

Lethal voltages are present at the battery terminals and cables connecting to the inverter. Severe injuries or death may occur if the cables and terminals in the inverter are touched.

Observe all safety information provided by the battery manufacturer.

⚠ WARNING

Damage to the product caused by incorrect wiring is not covered by the warranty.

- Electrical connection must be performed by professionals.
- Please use measuring devices with an appropriate range. Overvoltage can damage the measuring device and cause personal injury.
- All cables used in the PV generation system must be firmly attached, properly insulated, and adequately dimensioned.
- Do not damage the ground conductor. Do not operate the product in the absence of a properly installed ground conductor. Otherwise, it may cause personal injury or product damage.

⚠ WARNING

Check the positive and negative polarity of the PV strings, and connect the PV connectors to corresponding terminals only after ensuring polarity correctness.

During the installation and operation of the inverter, please ensure that the positive or negative poles of PV strings do not short-circuit to the ground. Otherwise, an AC or DC short-circuit may occur, resulting in equipment damage. The damage caused by this is not covered by the warranty.

The interfaces of the battery in the system must be compatible with the inverter.

The entire battery voltage range must be completely within the permissible range of the inverter, and the battery voltage shall not exceed the maximum permissible DC input voltage of the inverter.

NOTICE

- **Comply with the safety instructions related to PV strings and the regulations related to the local grid.**
- **Install the external protective grounding cable first when performing electrical connection and remove the external protective grounding cable last when removing the inverter.**

1.4 Operation Safety

DANGER

When routing cables, ensure a distance of at least 30 mm between the cables and heat-generating components or areas to protect the insulation layer of cables from aging and damage.

When the product is working:

- Do not touch the product enclosure.
- It is strictly forbidden to plug and unplug any connector on the inverter.
- Do not touch any wiring terminal of the inverter. Otherwise, electric shock may occur.
- Do not disassemble any parts of the inverter. Otherwise, electric shock may occur.
- It is strictly forbidden to touch any hot parts of the inverter (such as the heat sink). Otherwise, it may cause burns.
- Do not connect or remove any battery. Otherwise, electric shock may occur.
- Do not connect or remove any PV string or any PV module in a string. Otherwise, electric shock may occur.
- If the inverter is equipped with a DC switch, do not operate it. Otherwise, it may cause device damage or personal injury.

Do not take other actions, such as setting parameters, during the process of inverter firmware update, to avoid update failure.

1.5 Maintenance Safety

DANGER

Risk of inverter damage or personal injury due to incorrect service!

- Before maintenance, disconnect the AC circuit breaker on the grid side and then the DC switch. If a fault that may cause personal injury or device damage is found before maintenance, disconnect the AC circuit breaker and wait until the night before operating the DC switch. Otherwise, a fire inside the product or an explosion may occur, causing personal injuries.
- After the inverter is powered off for, measure the voltage and current with professional instrument. Only when there is no voltage nor current can operators who wear protective equipment operate and maintain the inverter.
- Even if the inverter is shut down, it may still be hot and cause burns. Wear protective gloves before operating the inverter after it cools down.

⚠ DANGER

Touching the power grid or the contact points and terminals on the inverter connected to the power grid may lead to electric shock!

- The power grid side may generate voltage. Always use a standard voltmeter to ensure that there is no voltage before touching.

⚠ CAUTION

To prevent misuse or accidents caused by unrelated personnel, post prominent warning signs or demarcate safety warning areas around the product.

NOTICE

To avoid the risk of electric shock, do not perform any other maintenance operations beyond those described in this manual. If necessary, contact your distributor first. If the problem persists, contact SUNGROW. Otherwise, the losses caused is not covered by the warranty.

NOTICE

- If the paint on the inverter enclosure falls or rusts, repair it in time. Otherwise, the inverter performance may be affected.
- Do not use cleaning agents to clean the inverter. Otherwise, the inverter may be damaged, and the loss caused is not covered by the warranty.
- As the inverter contains no parts that can be maintained, never open the enclosure of the inverter or replace any internal components without authorization. Otherwise, the loss caused is not covered by the warranty.
- Do not open the maintenance door in rainy or snowy weather. If it is inevitable, take proper protective measures to avoid the ingress of rainwater and snow into the maintenance compartment; otherwise, the product's operation may be affected.
- Before closing the maintenance door, check whether there is any object left inside the maintenance compartment, such as screws, tools, etc.
- It is recommended for users to use cable sheathing to protect the AC cable. If the cable sheathing is used, make sure it is positioned inside the maintenance compartment.

1.6 Disposal Safety

 **WARNING**

Please scrap the product in accordance with relevant local regulations and standards to avoid property losses or casualties.

2 Product Description

2.1 System Introduction

The inverter is a transformerless 1-phase hybrid inverter. As an integral component in the power system, the inverter is designed to convert the direct current power generated from the PV modules or batteries into grid-compatible AC current and feeds the AC current to the utility grid.

The 1-phase hybrid inverters are applicable to both on-grid and off-grid PV systems. With the integrated Energy Management System (EMS), they can control and optimize the energy flow so as to increase the self-consumption of the system.

WARNING

- **The inverter must only be operated with PV strings with class II protection in accordance with IEC 61730, application class A. It is not allowed for the positive pole or the negative pole of the PV strings to be grounded. This can cause the inverter to be destroyed.**
- **Damages to the product due to a faulty or damaged PV installation are not covered by warranty.**
- **Any use other than the one described in this document is not permitted.**
- **During the installation and operation of the inverter, please ensure that the positive or negative polarities of PV strings and those of batteries do not short-circuit to the ground. Otherwise, an AC or DC short-circuit may occur, resulting in equipment damage. The damage caused by this is not covered by the warranty.**
- **Do not short-circuit the Backup port during operation. Otherwise, the inverter or power distribution system will be seriously damaged. The loss is not covered by the SUNGROW warranty.**
- **Do not connect any local load between the inverter and the AC circuit breaker.**

NOTICE

- **For the TT utility grid, the N line voltage to ground must be 30 V or less.**
- **The utility grid must be a TN system for the off-grid application.**
- **The system is not suitable for supplying life-sustaining medical devices. It cannot guarantee backup power in all circumstances.**
- **The inverter applies only to the scenarios described in this manual.**

2.2 Product Introduction

Model Description

The model description is as follows (take SH5.0RS as an example):

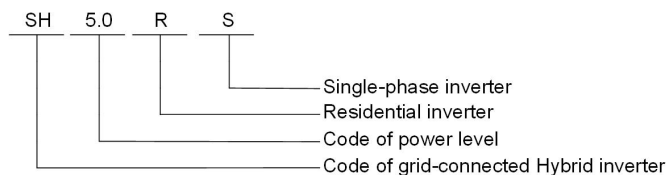

S007-G003

Appearance

The following figure shows the appearance of the inverter. The image shown here is for reference only. The actual product received may differ.

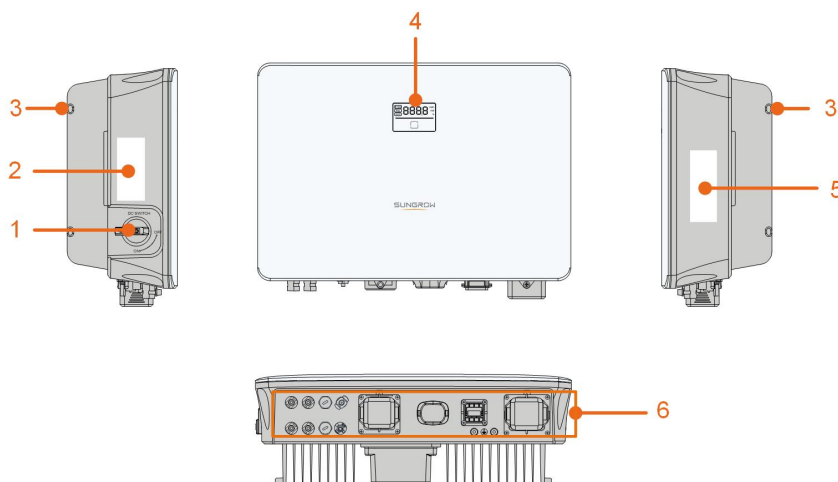

S007-G004

figure 2-1 Inverter Appearance

No.	Name	Description
1	DC switch	To safely disconnect the DC circuit whenever necessary.
2	Label	Information about COM2 pin definition, supported DRM modes, etc.
3	Hanger	To hang the inverter on the wall-mounting bracket.
4	LED panel	The LED screen indicates the running information and the LED indicator indicates the current working state of the inverter.

No.	Name	Description
5	Nameplate	To clearly identify the product, including device model, S/N, important specifications, marks of certification institutions, etc.
6	Electrical connection area	PV terminals, battery terminal, AC terminal, additional grounding terminal and communication terminals.

Dimensions

The following figure shows the dimensions of the inverter.

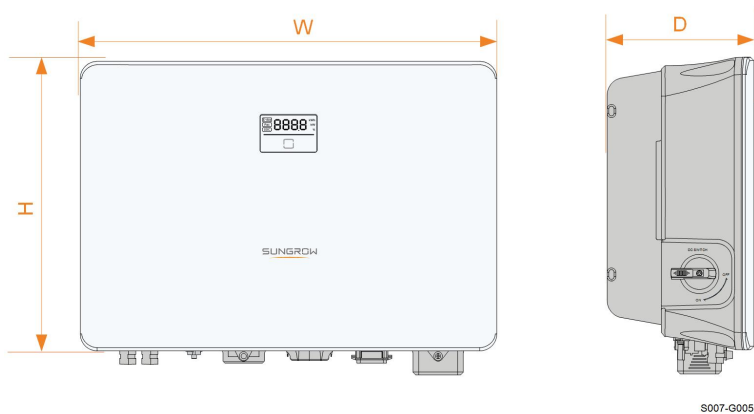











figure 2-2 Dimensions of the Inverter

Inverter Model	W (mm)	H (mm)	D (mm)
SH3.0RS / SH3.6RS / SH4.0RS / SH5.0RS / SH6.0RS	490	340	170

2.3 Symbols on the Product

Symbol	Explanation
	Parameters on the PV side.
	Parameters on the battery side.
	Parameters on the AC on-grid side.
	Parameters on the AC backup side.
	Regulatory compliance mark.
	TÜV mark of conformity.
	CE mark of conformity.

Symbol	Explanation
	UKCA mark of conformity.
	The inverter does not have a transformer.
	Do not dispose of the inverter together with household waste.
	Disconnect the inverter from all the external power sources before maintenance!
	Read the user manual before maintenance!
	Burn danger due to the hot surface that may exceed 60°C.
	Danger to life due to high voltages!
	Do not touch live parts for 10 minutes after disconnection from the power sources. Only qualified personnel can open and maintain the inverter.
	Additional grounding point.

* The table shown here is for reference only. The actual product received may differ.

2.4 LED Panel

The LED panel with a display screen and an indicator is on the front of the inverter.

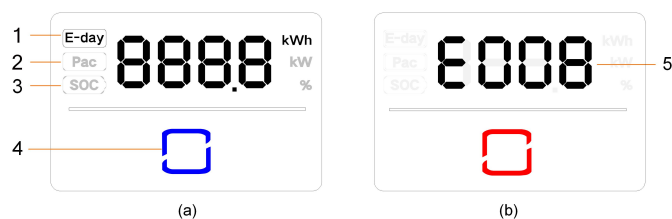

figure 2-3 LED Panel

(a) Normal state



(b) Error state

No.	Name	Description
1	E-day	Today's energy yield
2	Pac	Real-time AC output power
3	SOC	Battery SOC (State of Charge)

No.	Name	Description
4	LED indicator	To indicate the working state of the inverter. Touch it to switch the information in normal state or view multiple error codes in error state.
5	Error code	The error code in the figure is just an example.

- In normal state, the E-day, Pac and SOC information will be displayed alternately. Also you can touch the LED indicator to switch the information.
- In error state, touch the LED indicator to view error codes.
- If there is no operation for 5 minutes, the display screen will be off. Touch the LED indicator to activate it.

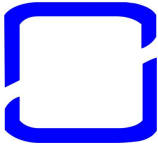
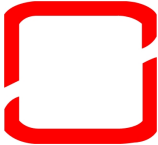
table 2-1 State description of the LED indicator

LED color	State	Definition
 Blue	On	The inverter is operating normally.
	Flashing	The inverter is at standby or startup state (not feeding power into the grid).
 Red	On	A system fault has occurred.
 Gray	Off	Both the AC and DC sides are powered down.

⚠ WARNING

Voltage may still be present in AC side circuits after the indicator is off. Pay attention to the electricity safety during operating.

2.5 DC Switch

The DC-Switch is used to disconnect or connect the PV-DC circuit when AC is turned off or DC current is below 0,5A.

The inverter operates automatically when input and output requirements are met. Rotate the DC switch to the “OFF” position to stop the inverter when a fault occurs. When you need to stop the inverter normally please first turn off AC and shut down the hybrid via app.



Turn the DC switch to the “ON” position before restarting the inverter.

2.6 PV Energy Storage System (PV ESS)

NOTICE

When designing the system, ensure that the operating ranges of all devices that are connected to the inverter meet the requirements of the inverter.

2.6.1 PV Energy Storage System (PV ESS)

The following figure shows inverter application in a PV energy storage system.

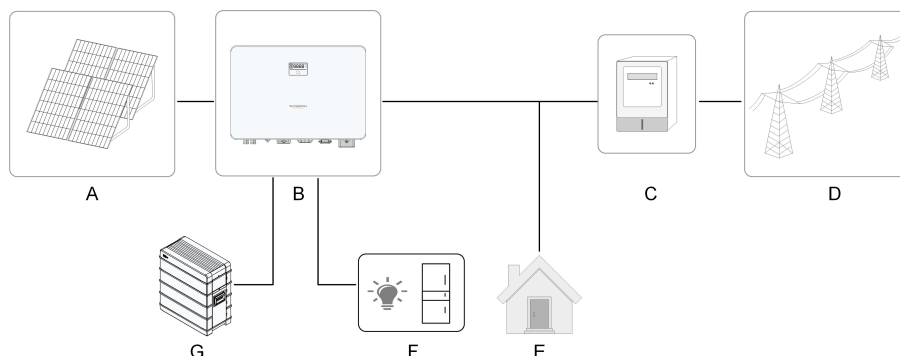

S007-G001

figure 2-4 PV Energy Storage System

Item	Description	Note
A	PV strings	Compatible with monocrystalline silicon, polycrystalline silicon, and thin-film modules without grounding.
B	Inverter	SH3.0RS, SH3.6RS, SH4.0RS, SH5.0RS, SH6.0RS
C	Metering device	Meter cupboard with power distribution system.
D	Utility grid	TT , TN-C , TN-S, TN-C-S.
E	Loads	Common loads, which will be lack of power when grid is blackout.
F	Protected house loads	Loads, connected to inverter backup port, which need uninterrupted power supply.
G	Battery (optional)	A Li-ion battery.

The following figure shows the common grid configurations.

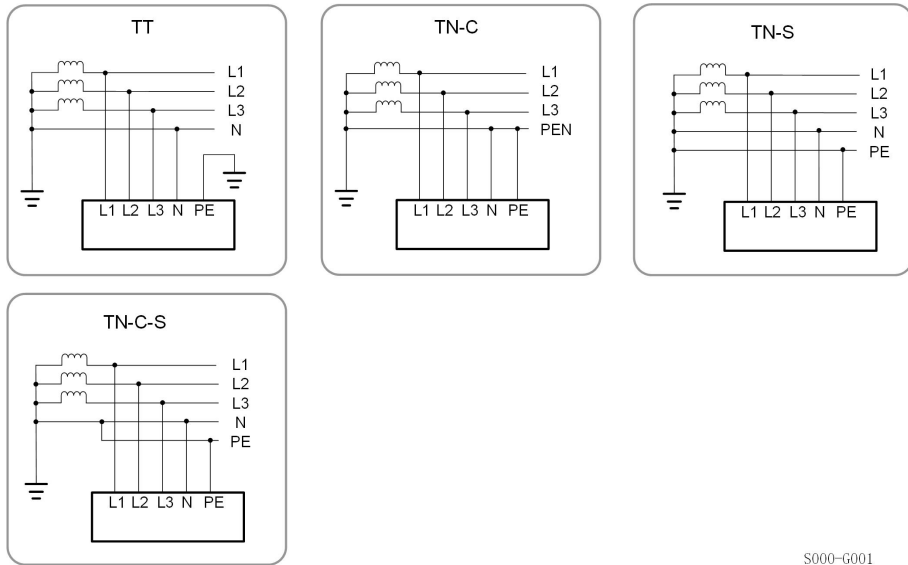

S000-G001

2.6.2 PV Storage and EV Charging System

A PV storage and charging system with chargers is as follows:

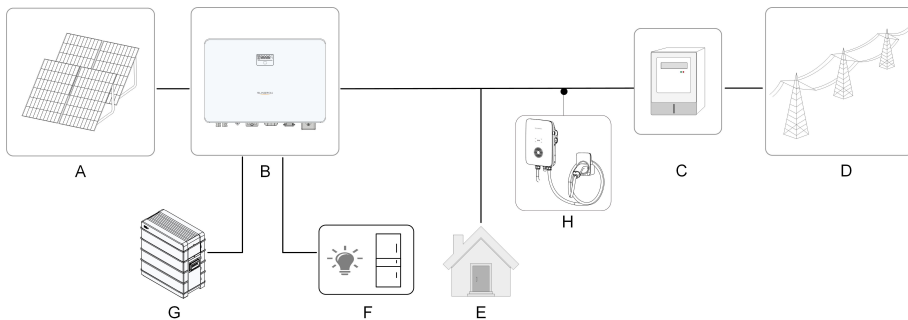

figure 2-5 PV Storage and EV Charger System

Item	Description	Note
A	PV strings	Compatible with monocrystalline silicon, polycrystalline silicon, and thin-film modules without grounding.
B	Inverter	SH3.0RS, SH3.6RS, SH4.0RS, SH5.0RS, SH6.0RS
C	Metering device	Meter cupboard with power distribution system.
D	Utility grid	TT, TN-C, TN-S, TN-C-S.
E	Loads	Common loads, which will be lack of power when grid is blackout.
F	Protected house loads	Loads, connected to inverter backup port, which need uninterrupted power supply.

Item	Description	Note
G	Battery (optional)	A Li-ion battery.
H	EV Charger (Optional)	AC007E-01



This system is only available in the European region.

2.6.3 Declaration For Backup Function

⚠ DANGER

This product is not suitable for supplying power to life-sustaining medical devices since power outages may result in danger to life.

The following statement involves SUNGROW general policies about the hybrid inverters described in this document.

- 1 For hybrid inverters, the electrical installation typically includes connection of the inverter to both PV modules and batteries. If there is no available power from batteries or PV modules in backup mode, the backup power supply will be automatically terminated. SUNGROW shall hold no liability for any consequences arising from failing to observe this instruction.
- 2 Normally, the backup switching time is less than 10 ms. However, some external factors or local regulations may cause the system to fail on backup mode. Therefore, the users must be aware of conditions and follow the instructions as below:
 - Do not connect loads that are dependent on a stable energy supply for a reliable operation.
 - Do not connect the loads whose total capacity is greater than the maximum backup capacity.
 - Due to the condition of the battery itself, battery current might be limited by some factors, including but not limited to the temperature and weather.

Declaration For Backup Overload Protection

The inverter will restart in case of overload protection. The time required for restarting will increase (10 min at most) if overload protection repeats. Try to reduce backup load power within maximum limitation or remove the loads which may cause very high start-up current surges.

2.7 Retrofitting the Existing PV System

The hybrid inverter is compatible with any single-phase PV grid-connected inverters. An existing PV system can be retrofitted to be a PV ESS with the addition of the hybrid inverter.

The power generation from the existing PV inverter will be firstly provided to the loads and then charge the battery. With the energy management function of the hybrid inverter, the self-consumption of the new system will be greatly improved.

Retrofit the Existing PV Inverter(s) to the Hybrid Inverter On-grid Port

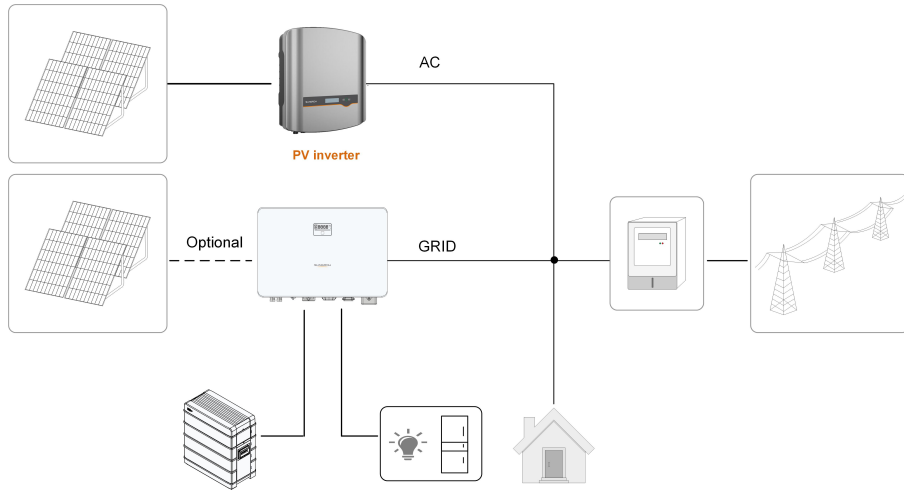

S007-G007

figure 2-6 Retrofit the Existing PV Inverter(s) to the Hybrid Inverter On-grid Port

The AC terminal of the PV inverter and the GRID terminal of the hybrid inverter are combined to the grid.

Retrofit the Existing PV Inverter(s) to the Hybrid Inverter Off-grid Port

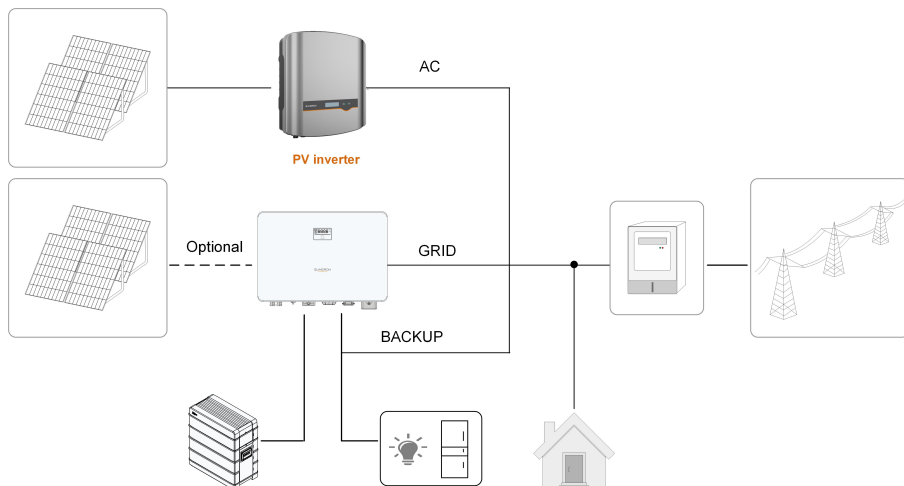

S007-G009

figure 2-7 Retrofit the Existing PV Inverter(s) to the Hybrid Inverter Off-grid Port

The off-grid port retrofits the existing PV system in order to maximize the use of PV energy by allowing the PV inverter to work even when off-grid.

The AC terminal of the PV inverter and the BACK-UP terminal of the hybrid inverter are combined to the backup loads.

The PV inverter power cannot exceed the nominal power of the hybrid inverter .



- In zero-export scenario, the hybrid inverter can only ensure no power exported to grid itself but does not ensure zero-export for the PV inverter. Please contact the PV inverter manufacturer for its zero-export solution.
- PV modules for hybrid inverter are optional.

3 Function Description

3.1 Safety Function

3.1.1 Protection

Several protective functions are integrated in the inverter, including short circuit protection, grounding insulation resistance surveillance, residual current protection, anti-islanding protection, DC overvoltage / over-current protection, etc.

3.1.2 Earth Fault Alarm

The device gives an alarm if there is a grounding fault. If the AC side is poorly grounded or not grounded, the buzzer rings, and the LED indicator turns red.

3.2 Energy Conversion and Management

The inverter converts the DC power from the PV array or the battery to the AC power, in conformity with the grid requirements. It also transmits the DC power from the PV panel to the battery.

With the bidirectional converter integrated inside, the inverter can charge or discharge the battery.

Multiple string MPP trackers are used to maximize the power from PV strings with different orientations, tilts, or module structures.

3.2.1 Power Derating

Power derating is a way to protect the inverter from overload or potential faults. In addition, the derating function can also be activated following the requirements of the utility grid. Situations requiring inverter power derating are:

- over-temperature (including ambient temperature and module temperature)
- high input voltage
- grid under-voltage
- grid over-voltage
- grid over-frequency
- power factor (when values out of the rated values)

3.2.2 DRM (“AU”/“NZ”)

The inverter provides a terminal block for connecting to a demand response enabling device (DRED). The DRED asserts demand response modes (DRMs). The inverter detects and initiates a response to all supported demand response commands within 2s.

The following table lists the DRMs supported by the inverter.

table 3-1 Demand Response Modes (DRMs)

Mode	Explanation
DRM0	The inverter is in the state of “Turn off”.
DRM1	The import power from the grid is 0.
DRM2	The import power from the grid is no more than 50 % of the rated power.
DRM3	The import power from the grid is no more than 75 % of the rated power.
DRM4	The import power from the grid is 100 % of the rated power, but subject to the constraints from other active DRMs.
DRM5	The feed-in power to the grid is 0.
DRM6	The feed-in power to the grid is no more than 50 % of the rated power.
DRM7	The feed-in power to the grid is no more than 75 % of the rated power.
DRM8	The feed-in power to the grid is 100 % of the rated power, but subject to the constraints from other active DRMs.

The DRED may assert more than one DRM at a time. The following shows the priority order in response to multiple DRMs.

Multiple Modes	Priority Order
DRM1...DRM4	DRM1 > DRM2 > DRM3 > DRM4
DRM5...DRM8	DRM5 > DRM6 > DRM7 > DRM8

3.2.3 Regular Operational Voltage Range

The inverters can operate within the allowable voltage range for at least the specified observation time. The setting of the conditions depends on whether the connection is due to a normal operational start-up or an automatic reconnection after disconnection from grid.

When the voltage level is out of the operational and protection levels, the inverter will disconnect within the specified time from the grid. If a disturbance lasts longer than the required protection time, the inverter can reconnect to the grid once the voltage level goes back to normal levels after the disturbance.

3.2.4 Regular Operational Frequency Range

The inverter can operate within its frequency range for at least the specified observation time. The setting of conditions depends on whether the connection is due to a normal operational start-up or an automatic reconnection after disconnection from grid.

When the frequency level is outside the operational and protection levels, the inverter will disconnect from the grid. If a disturbance lasts longer than the required protection time, the

inverter can reconnect to the grid once the frequency level goes back to normal levels after the disturbance.

3.2.5 Reactive Power Regulation

The inverter is capable of operating in reactive power regulation modes for the purpose of providing support to the grid. The reactive power regulation mode can be set via the iSolar-Cloud App.

3.3 Battery Management

Li-ion battery from SUNGROW and BYD are compatible with the PV ESS , further battery models will be made compatible in the future.

The currently supported battery brands and models are shown in the following table.

Brand	Model	Firmware Version
SUN-GROW	SBR064/096/128/160/192	≥ SBRBCU-S_22011.01.17
BYD	Battery-Box Premium HVM 8.3, 11.0, 13.8, 16.6, 19.3, 22.1	Battery management unit (BMU) version ≥ 3.7
	Battery-Box Premium HVS 5.1, 7.7, 10.2	Battery management system (BMS) version ≥ 3.16



The table is continually updated. If the battery model is not in the table, consult SUNGROW if it is supported.

To maximize the battery life, the inverter will perform battery charge, discharge, and battery maintenance based on the battery status communicated by the BMS.

NOTICE

The recommended parameters listed in this section may be updated or revised due to product development. Please refer to the manual supplied by the battery manufacturer for the latest information.

State Definition

In order to avoid overcharging or deep discharging of the battery, three battery statuses according to different voltage ranges has been defined, as shown in the following table.

table 3-2 Battery Status Definition

Type	Port Voltage / SOC		
	Empty	Normal	Full
SUNGROW (SBR064/096/128/ 160/192)	SOC < 5 %	5 %... 100 % (by default)	SOC = 100 %
BYD (Battery-Box Premium HVM / HVS)	SOC < 5 %	5 %...100 % (by default)	SOC = 100 %

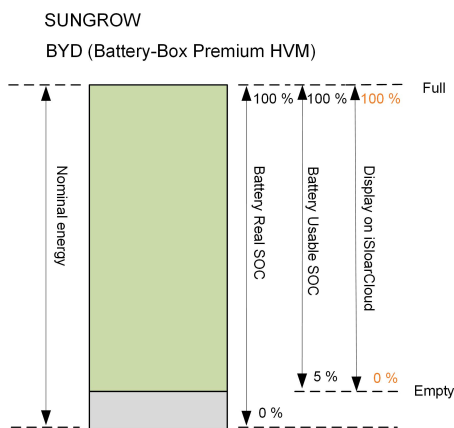

The SOC limits of Li-ion batteries can be modified via the iSolarCloud App by qualified personnel.

NOTICE

If the battery has not been used or fully charged for a long time, it is recommended to fully charge the battery manually every 15 days to ensure battery life and performance.

3.3.1 Charge Management

Backup Charge Management

The emergency charge management function is to protect the battery from the damage caused by long time excessive discharge. The inverter cannot respond to discharge command during emergency charge. The following tables describe the emergency charge conditions for different types of batteries.

table 3-3 Backup Charge Management for Li-ion Battery

Status	Conditions
Trigger	Either of the following conditions is met:
	<ul style="list-style-type: none"> • $SOC \leq (\text{Min. SOC}) - 3\%$ (valid only when the Min. SOC is $\geq 3\%$). • A battery under-voltage warning is triggered. • An emergency charge command is reported to the inverter.
	All the following conditions are met:
Finish	<ul style="list-style-type: none"> • $SOC \geq (\text{Min. SOC}) - 1\%$ (valid only when the Min. SOC is $\geq 3\%$). • The battery under-voltage warning is cleared. • The emergency charge command reported to the inverter is cleared.

table 3-4 Default SOC Conditions for Li-ion Battery Backup Charge

Type	Trigger SOC	Finishing SOC
SUNGROW	$SOC \leq 2\%$	$SOC \geq 4\%$
BYD (Battery-Box Premium HVM / HVS)	$SOC \leq 2\%$	$SOC \geq 4\%$

Normal Charge Management

When the battery voltage is within the normal range, the inverter can charge the battery if the PV power is higher than the load power and can ensure that the battery is never over-charged.

The maximum allowable charge current is limited to the smaller value among the following:

- the maximum charge current of the inverter (30A);
- the maximum / recommended charge current from the battery manufacturer.

For this reason, the battery charge power may not reach the nominal power.



- If the PV voltage is higher than the upper limit value of MPP voltage (560 V), the battery cannot charge.
- The hybrid inverter will start to charge the battery when the export power value exceeds a pre-defined threshold value of 70 W.

3.3.2 Discharge Management

Discharge management can effectively protect the battery from deep discharging.

The maximum allowable discharge current is limited to the smaller value among the following:

- the maximum discharge current of the inverter (30A);
- the maximum / recommended discharge current from the battery manufacturer.

For this reason, the battery discharge power may not reach the nominal power.



- If the PV voltage is higher than the upper limit value of MPP voltage (560 V), the battery cannot discharge.
- The hybrid system will start to discharge the battery when the import power value exceeds a threshold value of 70 W.

3.4 EV Charger Management

The currently supported EV charger brands and models are shown in the following table.

Brand	Model	Firmware Version
SUNGROW	AC007E-01	V1.3.459 or later

3.5 PID Recovery Function

The inverter is equipped with PID phenomenon recovery function to improve the PV power generation. During the power generation process, the inverter could carry out a main Anti-PID function without any influence to the grid side thanks to a particular technology.

- P-type panels

The PID recovery function only applies to P-type panels. When it is enabled, the inverter raises the potential between the negative pole of PV arrays of P-type panels and the ground through PID module, to recover the PID effect.

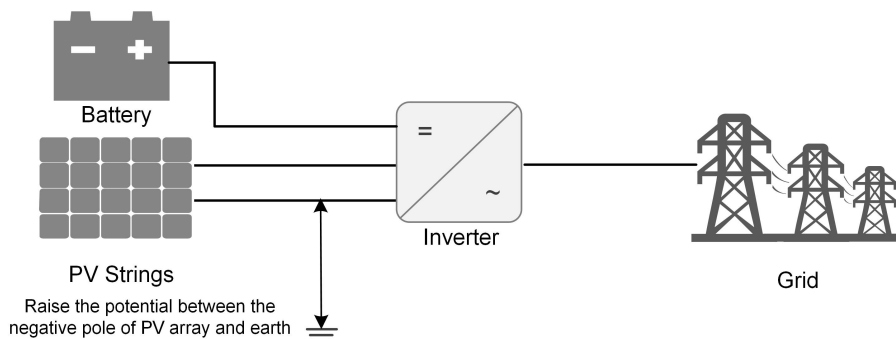

figure 3-1 PID Recovery Scheme



- The PID recovery function is inapplicable to N-type panel, please disable it;
- About 20W is consumed during PID recovery at night.

⚠ DANGER

Keep the DC switch "ON" in the PID recovery process. During the process, there is voltage hazard between inverter / PV module live conductors and ground. Do not touch any of them.

3.6 Communication and Configuration

The inverter possesses various ports for device and system monitoring, including RS485, Ethernet, WLAN, and CAN; various parameters can be configured for optimal operation. The inverter information is accessible through the iSolarCloud App.

3.7 Import Power Limit Function

Import power means the total power purchased from grid, which includes power to charge the battery from grid via inverter, power consumed by local loads and loads connected to inverter backup port from grid. Following local regulations, calculate the maximum system tolerable power based on the wire and circuit breaker that required by the selected model, and the value can be set as the **Import Power Limit**. **Import Power Limit** can be set on the iSolarCloud App.

3.8 Optimizer Functions

- Module-level MPPT

Increase the power generation of the PV system by continuously tracking the maximum power point of the PV module.

- Module-level shutdown

Quickly reduce module voltage.

- Module-level monitoring

The optimizer can monitor the performance of modules.

- Module-level IV curve diagnosis

The optimizer can scan the module IV curve and judge whether a module fault occurs.

4 Unpacking and Storage

4.1 Unpacking and Inspection

The product is thoroughly tested and strictly inspected before delivery. Nonetheless, damage may still occur during shipping. For this reason, please conduct a thorough inspection after receiving the product.

- Check the packing case for any visible damage.
- Check the scope of delivery for completeness according to the packing list.
- Check the inner contents for damage after unpacking.

Contact SUNGROW or the transport company in case of any damage or incompleteness, and provide photos to facilitate services.

Do not dispose of the original packing case. It is recommended to store the device in the original packing case when the product is decommissioned.

NOTICE

After receiving the product, check whether the appearance and structural parts of the device are damaged, and check whether the packing list is consistent with the actual ordered product. If there are problems with the above inspection items, do not install the device and contact your distributor first. If the problem persists, contact SUNGROW in time.

If any tool is used for unpacking, be careful not to damage the product.

4.2 Scope of Delivery

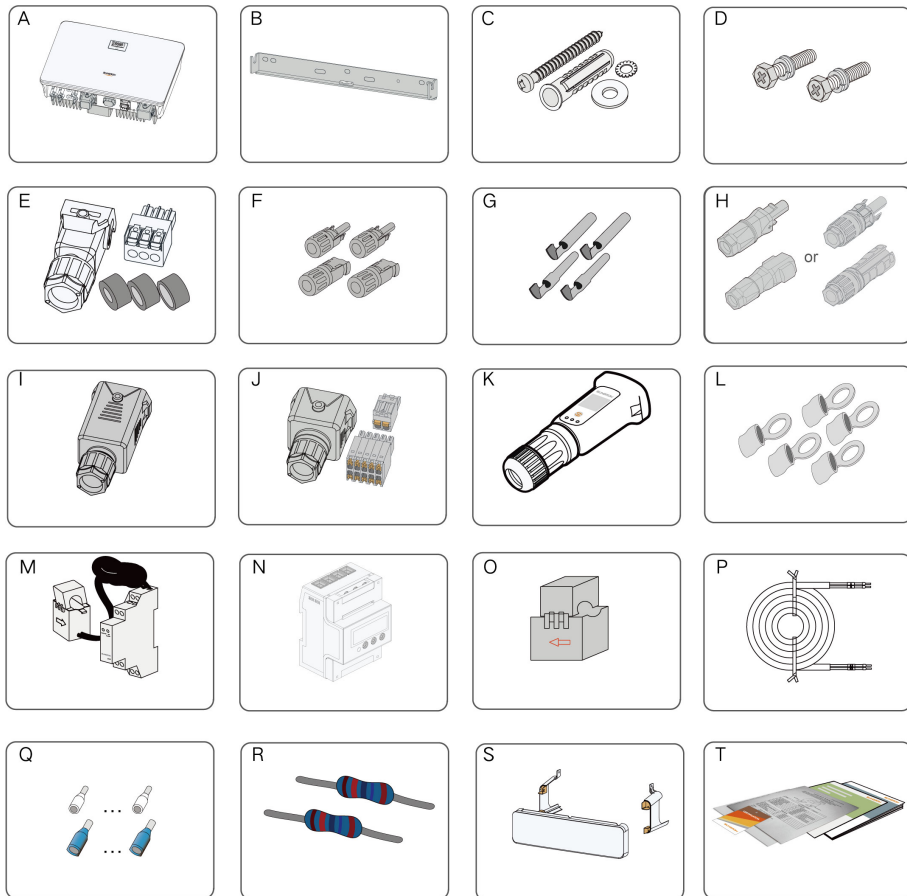

figure 4-1 Scope of delivery

Item	Name	Quantity
A	Inverter	1
B	Wall-mounting bracket *	1
C	Expansion plug set	3
D	M4×16 screws set	2
E	Backup connector set	2
F	PV connectors	2
G	Crimp contact	2
H	Battery connector *	2
I	Grid connector	1
J	COM connector set	1
K	WiNet-S module/WiNet-S2 module**	1
L	OT terminal *	1
M	Single-phase Meter***	1
N	Smart Energy Meter***	1

Item	Name	Quantity
O	Current Transformer(CT)	2
P	Meter RS485 cable	1
Q	Cord end terminals (for COM2) *	—
R	120Ω resistor	2
S	Protective Cover	1
T	Documents	1

* The images shown here are for reference. The actual product and quantity are based on delivery.

** For PV systems with EV chargers, the use of WiNet-S2/WiNet-S as a communication module is supported.

*** Types of meter to be applied vary in different regions. Please consult local customer service for meter type selection.

4.3 Inverter Storage

Proper storage is required if the inverter is not installed immediately.

- Store the inverter in the original packing case with the desiccant inside.
- The storage temperature must be always between -30°C and +70°C, and the storage relative humidity must be always between 0 and 95 %, non-condensing.
- In case of stacking storage, the number of stacking layers should never exceed the limit marked on the outer side of the packing case.
- The packing case should be upright.
- If the inverter needs to be transported again, pack it strictly before loading and transporting it.
- Do not store the inverter in places susceptible to direct sunlight, rain, and strong electric field.
- Do not place the inverter in places with items that may affect or damage the inverter.
- Store the inverter in a clean and dry place to prevent dust and water vapor from eroding.
- Do not store the inverter in places with corrosive substances or susceptible to rodents and insects.
- Carry out periodic inspections. Inspection shall be conducted at least once every six months. If any insect or rodent bites are found, replace the packaging materials in time.
- If the inverter has been stored for more than a year, inspection and testing by professionals are required before it can be put into operation.

NOTICE

Please store the inverter according to the storage requirements. Product damage caused by failure to meet the storage requirements is not covered by the warranty.

5 Mechanical Mounting

WARNING

Respect all local standards and requirements during mechanical installation.

5.1 Safety During Mounting

DANGER

Make sure there is no electrical connection before installation.
Before drilling, avoid the water and electricity wiring in the wall.

WARNING

For specific requirements for the installation environment, see "[5.2.1 Installation Environment Requirements](#)". In case the environment where the product is installed does not meet the requirements, SUNGROW shall not be held liable for any property damage arising therefrom.

CAUTION

Improper handling may cause personal injury!

- When moving the product, be aware of its weight and keep the balance to prevent it from tilting or falling.
- Wear proper protective equipment before performing operations on the product.
- The bottom terminals and interfaces of the product cannot directly contact the ground or other supports. The product cannot be directly placed on the ground.

NOTICE

During installation, ensure that no device in the system causes it hard for the DC switch and the AC circuit breaker to act or hinders maintenance personnel from operating.

If drilling is required during installation:

- Wear goggles and protective gloves when drilling holes.
- Make sure to avoid the water and electricity wiring in the wall before drilling.
- Protect the product from shavings and dust.

5.2 Location Requirements

To a large extent, a proper installation location ensures safe operation, service life, and performance of the inverter.

- The inverter with protection rating IP65 can be installed both indoors and outdoors.
- The inverter should be installed at a height that allows easy viewing of the LED indicator panel, as well as easy electrical connection, operation and maintenance.

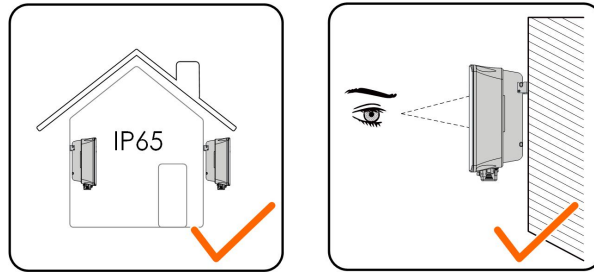

S006-I001

5.2.1 Installation Environment Requirements

- If the inverter is installed in a place with lush vegetation, weed on a regular basis. In addition, the ground beneath the inverter needs to undergo certain treatment, such as laying cement or gravel, etc. (an area of 3m×2.5m is recommended).
- Do not install the inverter in an environment with flammables, explosives, or smoke.
- Do not install the inverter in places prone to water leak, e.g., under the air-conditioner vent, the air vent, or the cable outlet window of the machine room, so as to prevent device damage or short circuit caused by intrusion of water.
- Do not install the inverter in a place with corrosives such as corrosive gas and organic solvent, etc.
- When the inverter is running, its surface may carry high voltages or get very hot. Do not touch it; otherwise, it may lead to burns or electric shocks.
- Do not install the inverter in a place that is easy to reach for people.
- Good heat dissipation is very important to the inverter. Please install the inverter in a ventilated environment.
- Please consult SUNGROW before installing inverters outdoors in areas prone to salt damage, which mainly are coastal areas within 500 meters of the coast. The sedimentation amount of salt spray is correlated to the characteristics of the seawater, sea winds, precipitation, air humidity, topography, and forest coverage in the adjacent sea areas, and there are substantial differences between different coastal areas.
- Do not install the inverter in an environment contaminated with chemicals such as halogen and sulfide.
- Do not install the inverter in an environment with vibration and strong electromagnetic field. Strong-magnetic-field environments refer to places where magnetic field strength measures over 30 A/m.

- In dusty environments such as places full of dust, smoke, or floc, particles may cling to the device's air outlet or heat sink, thus impacting its heat dissipation performance or even getting it damaged. Therefore, do not install the inverter in dusty environments. If the inverter has to be installed in such environments, please clean its fans and heat sink on a regular basis to ensure a good heat dissipation performance.
- The average temperature approximately 1 m around the inverter should be taken as its operating temperature. The temperature and humidity should meet the requirements below:

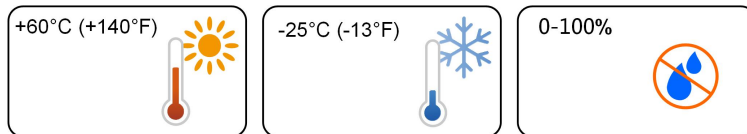

5.2.2 Carrier Requirements

The mounting structure where the inverter is installed must comply with local/national standards and guidelines. Ensure that the installation surface is solid enough to bear four times the weight of the inverter and is suitable for the dimensions of the inverter (e.g. cement walls, plasterboard walls, etc.).

Do not install the inverter on a carrier that may vibrate in resonance, so as to avoid making bigger noise.

The structure should meet the following requirements:



S006-I003

5.2.3 Angle Requirements

Install the inverter vertically. Never install the inverter horizontally, or at forward/backward tilted, side tilted, or upside down.

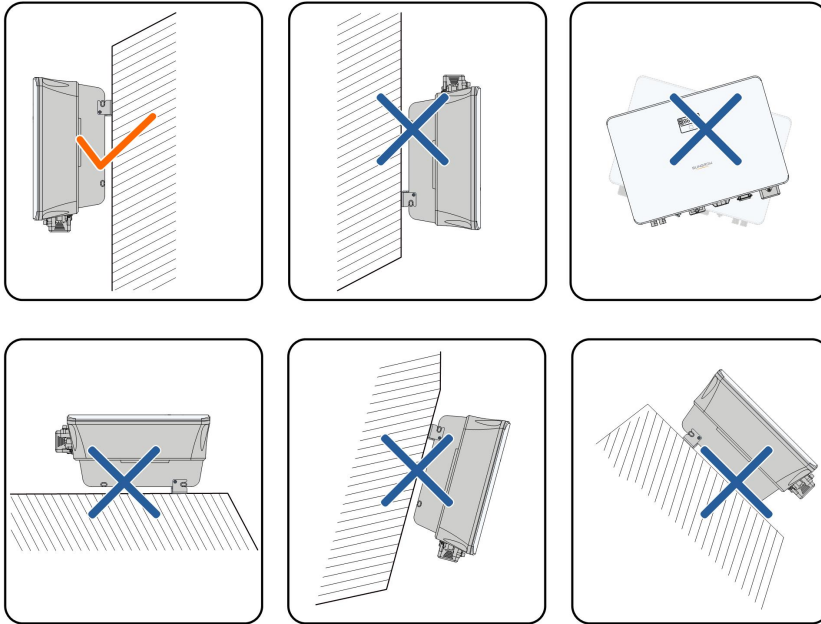

S007-I004

5.2.4 Clearance Requirements

Reserve enough clearance around the inverter to ensure sufficient space for heat dissipation.

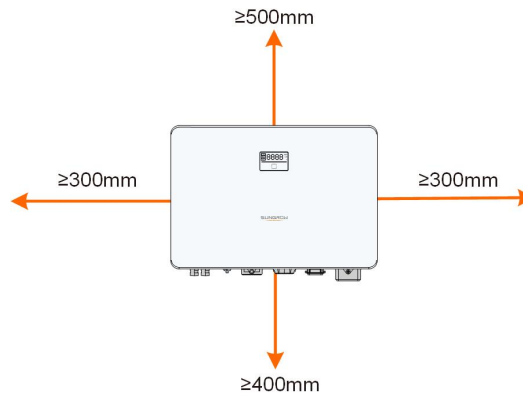

S007-I005

In case of multiple inverters, reserve specific clearance between the inverters.

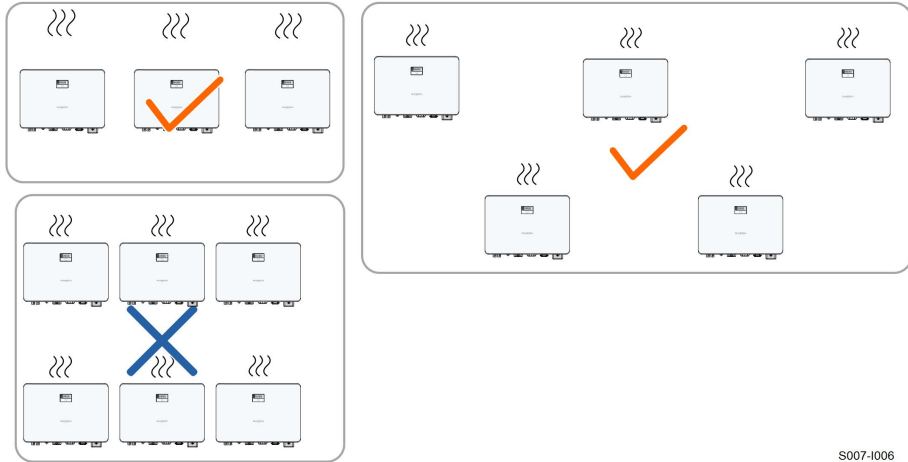

S007-1006

Install the inverter at an appropriate height for ease of viewing the screen and LED indicator and operating switch(es).

5.3 Installation Tools

Installation tools include but are not limited to the following recommended ones. If necessary, use other auxiliary tools on site.

table 5-1 Tool specification

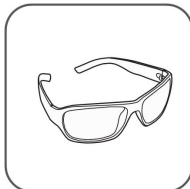

Goggles

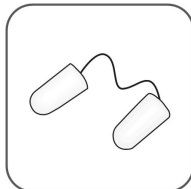

Earplugs

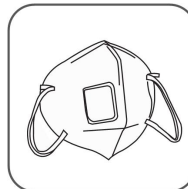

Dust mask



Safety gloves



Safety shoes



Utility knife

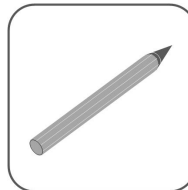

Marker

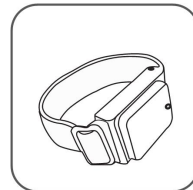

Anti-static wrist strap

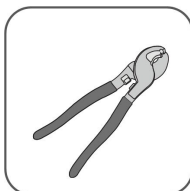

Wire cutter

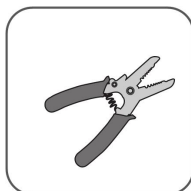

Wire stripper

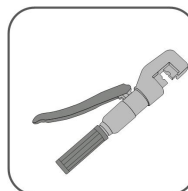

Hydraulic pliers

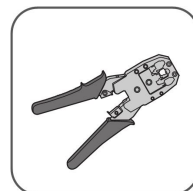

RJ45 crimping tool



MC4 terminal crimping tool (4 mm²–6mm²)



OT terminal crimping tool (0.5 mm²–1.0mm²)

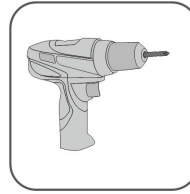

Electric screwdriver (M4, M5, M6)

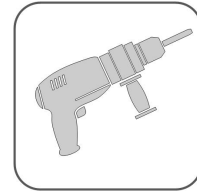

Hammer drill (φ10)



Phillips screwdriver (M4)



Vacuum cleaner

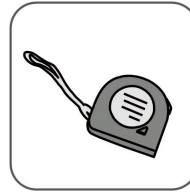

Measuring tape

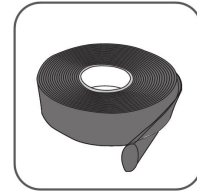

Heat shrink tubing



Heat gun

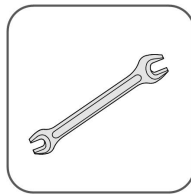

Open-end wrench (33mm, 35 mm)

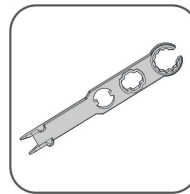

Connector wrench

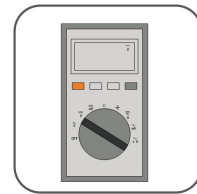

Multimeter (≥ 600 Vdc)

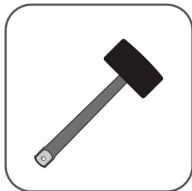

Rubber mallet

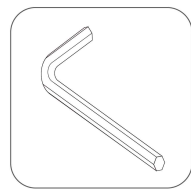

Allen wrench(T27)

5.4 Moving the Inverter

Before installation, remove the inverter from the packing case and move it to the installation site. Follow the instructions below as you move the inverter:

- Always be aware of the weight of the inverter.
- Lift the inverter using the handles positioned on both sides of the inverter.
- Move the inverter by one or two people or by using a proper transport tool.
- Do not release the equipment unless it has been firmly secured.

⚠ CAUTION

Improper handling may cause personal injury!

- Arrange an appropriate number of personnel to carry the inverter according to its weight, and installation personnel should wear protective equipment such as anti-impact shoes and gloves.
- Attention must be paid to the center of gravity of the inverter to avoid tilting during handling.
- Placing the inverter directly on a hard ground may cause damage to its metal enclosure. Protective materials such as sponge pad or foam cushion should be placed underneath the inverter.
- Move the inverter by holding the handles on it. Do not move the inverter by holding the terminals.

5.5 Installing Mounting-bracket

The inverter can be installed on a bracket, a wall, and a pole by means of mounting-bracket. Dimensions of the assembled mounting-bracket are as follows.

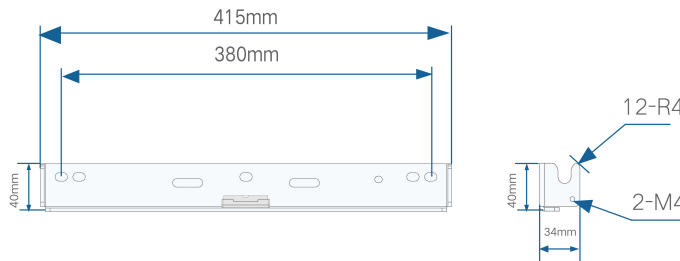
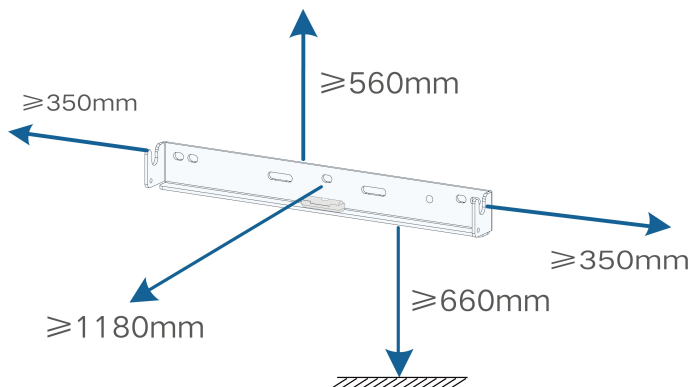

figure 5-1 Dimensions of Mounting-bracket

Reserve enough space when installing the mounting-bracket to meet the installation space requirements of the inverter.



5.6 Installing the Inverter

Inverter is installed on the wall by means of wall-mounting bracket and the expansion plug sets.

The expansion plug set shown below is recommended for the installation.

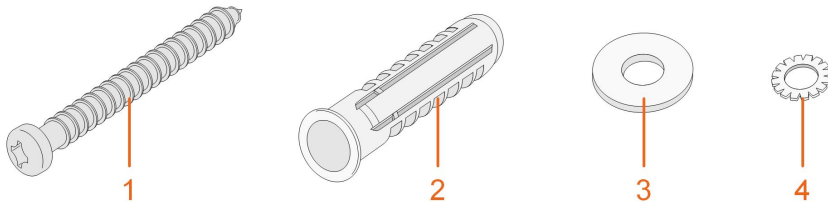

(1) Self-tapping screw M6 (2) Expansion tube (3) Fender washer (4) Spring washer

step 1 Place the wall-mounting bracket to a proper position on the wall. Mark the positions and drill the holes.

NOTICE

Observe the level on the bracket and adjust until the bubble is in the middle position.

The depth of the holes should be about 70 mm.

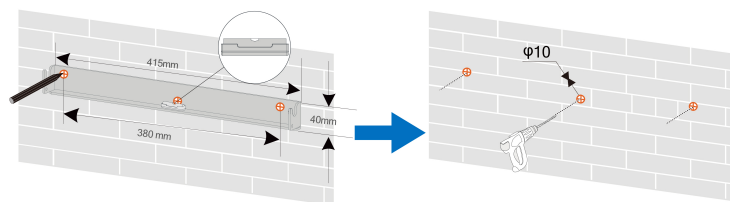

S006-1008

* The image shown here is for reference only. The actual product received may differ.

step 2 Place the expansion tubes into the holes. Then secure the wall-mounting bracket to the wall firmly with the expansion bolt sets.

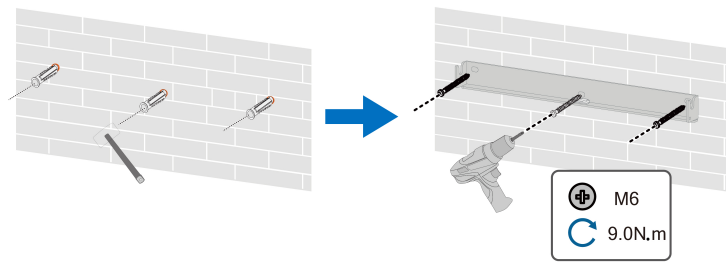

S006-1009

step 3 Lift the inverter and slide it down along the wall-mounting bracket to make sure they match perfectly. Use two screw sets to lock both left and right sides.

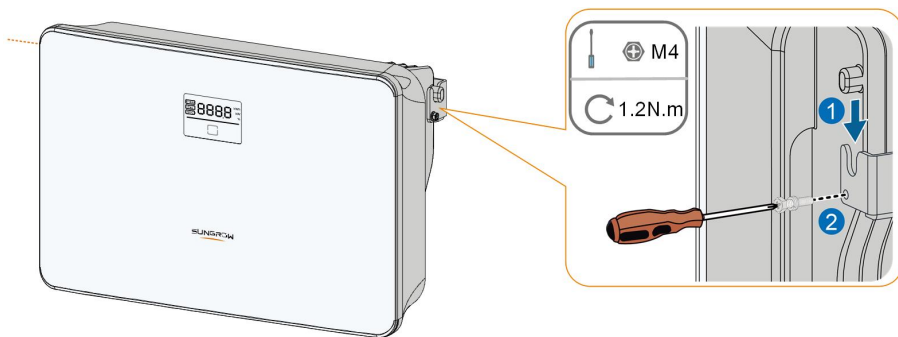

S007-1010

-- End

5.7 Installing Optimizer(Optional)

step 1 As shown in the figure below, clamp the optimizer parallel to the back of the PV module by clips.

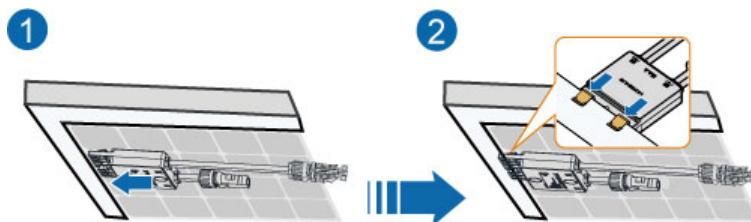

NOTICE

- Please ensure that the optimizer is installed facing the back of the module. Otherwise, the clip may get damaged.

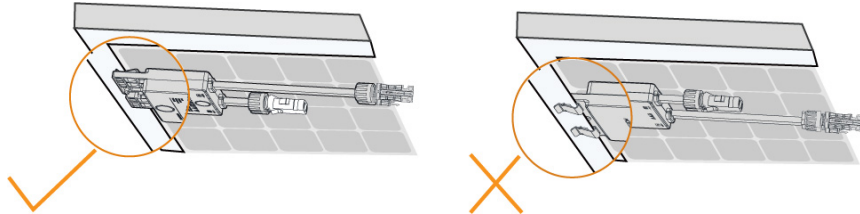

- Do not forcibly bend the clips when installing the optimizer by clips. Otherwise, the clip may be damaged.

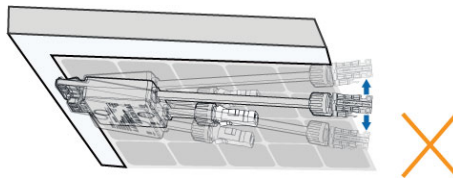

- Do not clamp the optimizer into holes in the module frame during installation. Otherwise, the optimizer cannot be removed or the clips may be damaged.

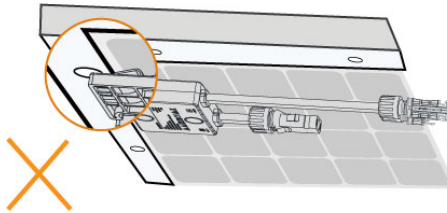

- It is recommended to install optimizers on the same side of modules.
- Do not clamp and remove the optimizer multiple times. Otherwise, the clip may become loose, affecting normal use.

-- End

6 Electrical Connection

6.1 Safety Instructions

DANGER

The PV string will generate lethal high voltage when exposed to sunlight.

- Operators must wear proper personal protective equipment during electrical connections.
- Must ensure that cables are voltage-free with a measuring instrument before touching DC cables.
- Respect all safety instructions listed in relevant documents about PV strings.

DANGER

- Before electrical connections, please make sure that the inverter switch and all switches connected to the inverter are set to "OFF", otherwise electric shock may occur!
- Ensure that the inverter is undamaged and all cables are voltage free before performing electrical work.
- Do not close the AC circuit breaker until the electrical connection is completed.

WARNING

Do not damage the ground conductor. Do not operate the product in the absence of a properly installed ground conductor. Otherwise, it may cause personal injury or product damage.

Please use measuring devices with an appropriate range. Overvoltage can damage the measuring device and cause personal injury.

Damage to the product caused by incorrect wiring is not covered by the warranty.

- Electrical connection must be performed by professionals.
- Operators must wear proper personal protective equipment during electrical connections.
- All cables used in the PV generation system must be firmly attached, properly insulated, and adequately dimensioned. Cables used shall comply with the requirements of local laws and regulations.
- The factors that affect cable selection include rated current, cable type, routing mode, ambient temperature, and maximum expected line loss.

NOTICE

All electrical connections must comply with local and national/regional electrical standards.

- **Cables used by the user shall comply with the requirements of local laws and regulations.**
- **Only with the permission of the national/regional grid department, the inverter can be connected to the grid.**

NOTICE

- **Install the external protective grounding cable first when performing electrical connection and remove the external protective grounding cable last when removing the inverter.**
- **Keep the AC output cable and the DC input cable close to each other during electrical connection.**
- **Comply with the safety instructions related to PV strings and the regulations related to the utility grid.**

NOTICE

- **After being crimped, the OT terminal must wrap the wires completely, and the wires must contact the OT terminal closely.**
- **When using a heat gun, protect the device from being scorched.**
- **Keep the PV+ cable and PV- cable close to each other when connecting DC input cables.**
- **Before connecting a power cable (such as the AC cable, the DC cable, etc.), confirm that the label and identifier on the power cable are correct.**
- **When laying out communication cables, separate them from power cables and keep them away from strong interference sources to prevent communication interruption.**
- **All vacant terminals must be covered with waterproof covers to prevent affecting the protection performance.**
- **Ensure that AC output cables are firmly connected. Failing to do so may cause inverter malfunction or damage to its AC connectors.**
- **When the wiring is completed, seal the gap at the cable inlet and outlet holes with fireproof/waterproof materials such as fireproof mud to prevent foreign matter or moisture from entering and affecting the long-term normal operation of the inverter.**



The cable colors in figures in this manual are for reference only. Please select cables according to local cable standards.

6.2 Terminal Description

All electrical terminals are located at the bottom of the inverter.

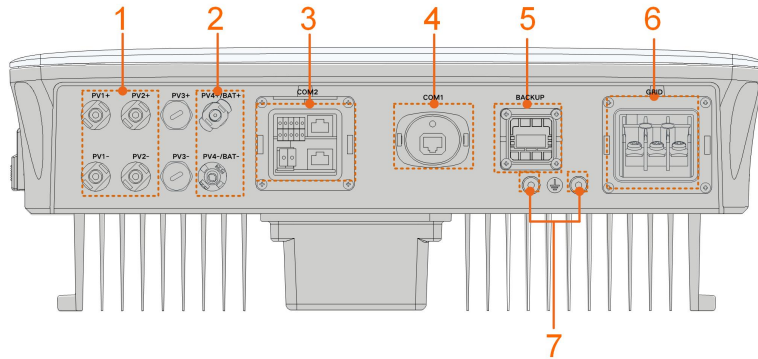

S007-E001

figure 6-1 Terminals

* The image shown here is for reference only. The actual product received may differ.

table 6-1 Terminal Description

No.	Name	Description	Decisive Voltage Classification
1	PV1+, PV1-, PV2+, PV2-	MC4 terminals for PV input. The terminal number depends on inverter model.	DVC-C
2	PV4+/BAT+, PV4-/BAT-	Connectors for the battery power cables	DVC-C
3	COM2	Communication connection for RSD, BMS, RS485, DRM/DI, DO and smart energy meter.	DVC-A
4	COM1	Communication accessory port to be connected to WiNet-S/WiNet-S2 communication module.	DVC-A
5	BACKUP	AC terminal for Backup loads	DVC-C
6	GRID	AC terminal to connect to the grid.	DVC-C
7		Additional grounding terminal.	Not applicable



PV3± and PV4± are not applicable to Hybrid inverter.
Do not connect PV strings to PV4±/BAT± ports.

The pin definition of COM2 terminal is shown in the following label.

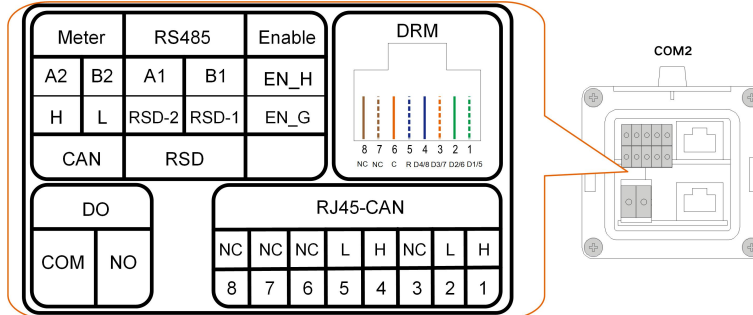

figure 6-2 Label of COM2 Terminal

table 6-2 Label Description of COM2 Terminal

Label	Description
Meter	A2, B2 For Smart Energy Meter, Sungrow AC007E-01 EV-Charger (alternative)
CAN	H, L For Li-ion battery communication via CAN protocol. Sungrow AC007E-01 EV-Charger COM port(default)
RS485	A1, B1 For inverter daisy chain (Reserved) For Li-ion battery communication via RS485 protocol.
RSD	RSD-1, RSD-2 Reserved (Detail availability contact SUNGROW)
Enable	EN_H, EN_G Enable the battery with a voltage of 12V.
DRM	D1/5, D2/6, D3/7, D4/8, R, C For external Demand Response Enabling Device ("AU"/"NZ") For Ripple Control Receiver
DO	COM, NO Reserved (Detail availability contact SUNGROW)
RJ45-CAN	H, L For Li-ion battery communication via CAN protocol.

6.3 Electrical Connection Overview

The electrical connection should be realized as follows:

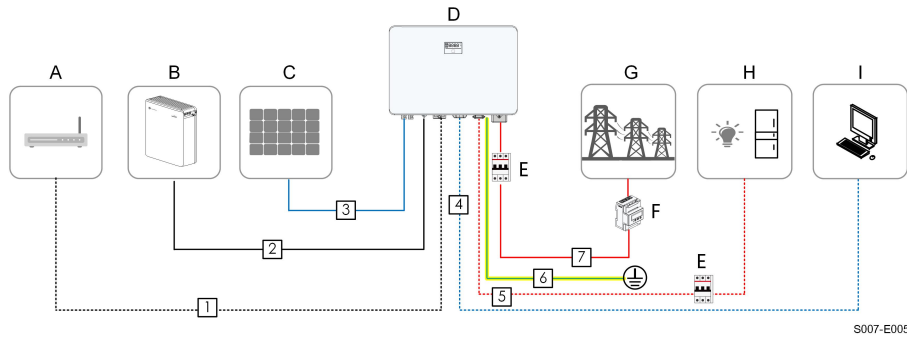

S007-E005

- (A) Router
- (B) Battery
- (C) PV string
- (D) Inverter
- (E) AC circuit breaker
- (F) Smart energy meter
- (G) Grid
- (H) Backup loads
- (I) Monitoring device
- (J) EV-Charger

WARNING

Install an AC circuit breaker on the backup side. Otherwise, an electrical short circuit may occur, causing damage to the inverter.

NOTICE

Ensure that AC output cables are firmly connected. Failing to do so may cause inverter malfunction or damage to its AC connectors.

table 6-3 Cable Requirements

No.	Cable	Type	Cable Diameter	Cross-section
1	Ethernet cable	CAT 5E outdoor shielded network cable	4.8 – 6 mm	0.08 – 0.2 mm ²
2	Battery power cable	Complying with 600 V and 35A standard	5.5 – 8 mm	6 mm ²
3	PV cable	Outdoor multi-core copper wire cable complying with 600 V and 16 A standard	6 – 9 mm	4 – 6 mm ²
4	Communication cable	Shielded twisted pair	4.8 – 6 mm	0.5 – 1.0 mm ²

No.	Cable	Type	Cable Diameter	Cross-section
		CAT 5E outdoor shielded network cable	4.8 – 6 mm	0.08 – 0.2 mm ²
5	Backup cable	Outdoor 3-core copper wire cable	10 – 21 mm	4 – 6 mm ² (Recommend SH3.0RS: 4 mm ² , Others: 6 mm ²)
6	Additional Grounding cable	Outdoor single-core copper wire cable	The same as that of the PE wire in the AC cable	
7	AC cable	Outdoor 3-core copper wire cable	12 – 25.8 mm	6 – 16 mm ² (Recommend 10 mm ²)

If local standard have other requirements for cables, set the cable specification according to the local standard.

The factors that affect cable selection include rated current, cable type, routing mode, ambient temperature, and maximum expected line loss.

The cabling distance between the battery and the inverter should be less than 10 m, and within 5 m is recommended.

6.4 Backup Wiring Diagram

For AU/NZ/SA

For Australia, New Zealand and South Africa, the neutral cable of GRID side and BACK-UP side must be connected together. Otherwise BACK-UP function will not work.

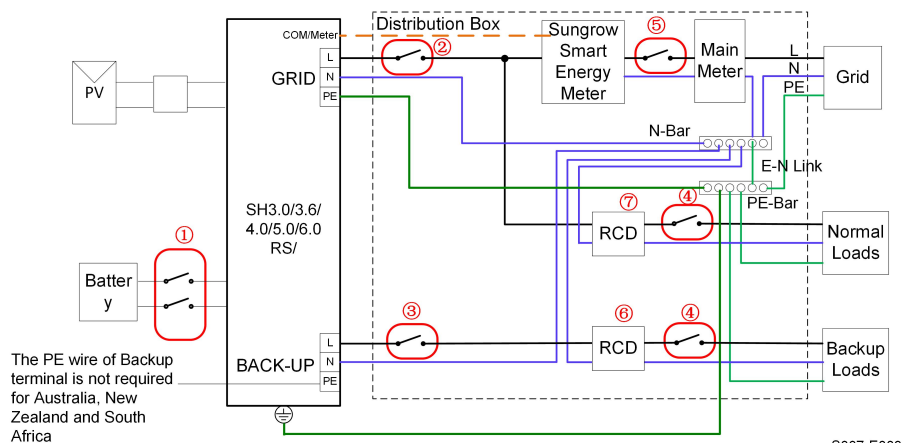

S007-E003

NO.	SH3.0/3.6/4.0/5.0/6.0RS
①	40A/600V DC breaker *
②	≤63A/230V/400V AC breaker
③	32A/230V/400V AC breaker

NO.	SH3.0/3.6/4.0/5.0/6.0RS
④	Depends on loads
⑤	Depends on household loads and inverter capacity
⑥⑦	30mA RCD (Comply with local regulation)

Note 1: * If the battery is integrated with a readily accessible internal DC breaker, no additional DC breaker is required.

Note 2: The recommended values in the table are for reference only. The actual values must comply with local standard and actual conditions.

Note 3: The rated current of breaker ② is suggested to lower than that of breaker ⑤.

Note 4: If the rated current of on-site power cables are lower than those recommended above, the breakers specification should be considered to match the power cables in first priority.

Note 5: The AC port takes power from the grid and is set according to the grid circuit breaker.

For other countires

For other countires, the following diagram is an example for grid systems without special requirement on wiring connection.

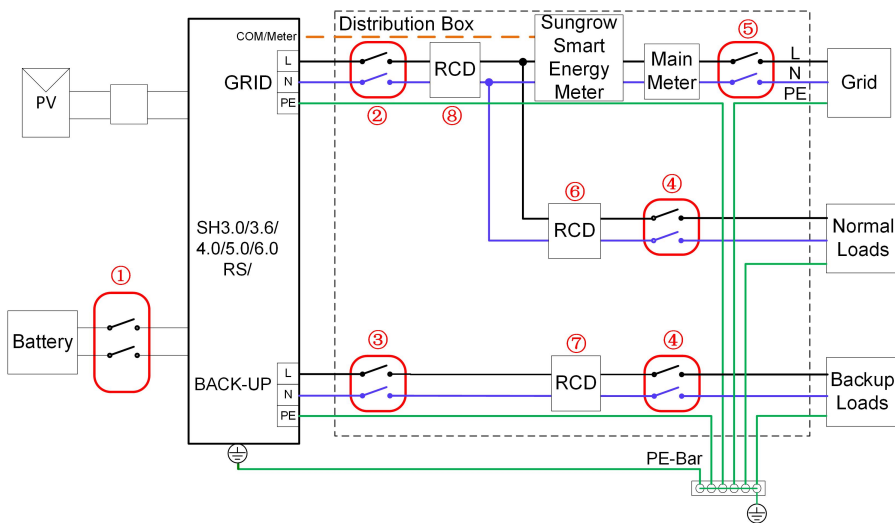

S007-E004

NO.	SH3.0/3.6/4.0/5.0/6.0RS
①	40A/600V DC breaker *
②	≤63A/230V/400V AC breaker
③	32A/230V/400V AC breaker
④	Depends on loads
⑤	Depends on household loads and inverter capacity (Optional)
⑥⑦	30mA RCD (Recommended)
⑧	300mA RCD (Recommended)

Note 1: * If the battery is integrated with a readily accessible internal DC breaker, no additional DC breaker is required.

Note 2: The recommended values in the table are for reference only. The actual values must comply with local standard and actual conditions.

Note 3: The rated current of breaker ② is suggested to lower than that of breaker ⑤.

Note 4: If the rated current of on-site power cables are lower than those recommended above, the breakers specification should be considered to match the power cables in first priority.

Note 5: The AC port takes power from the grid and is set according to the grid circuit breaker.

For TT system

In the TT system, the following diagram is an example for grid systems without special requirement on wiring connection.

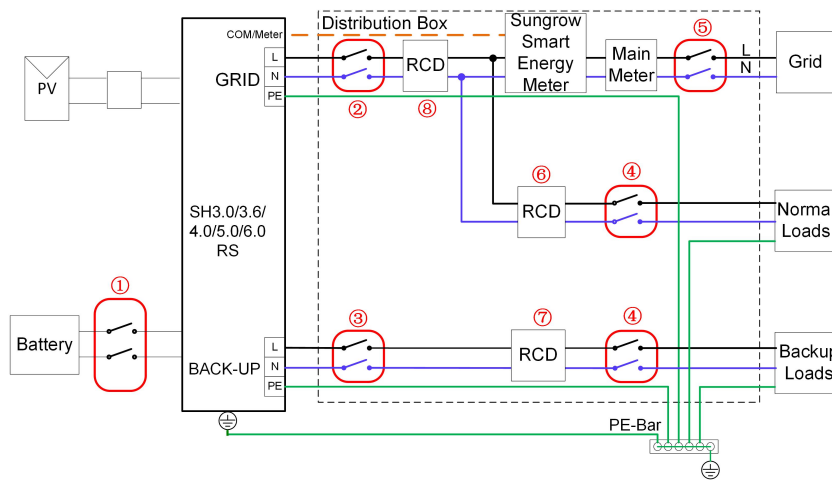

S007-E005

NO.	SH3.0/3.6/4.0/5.0/6.0RS
①	40A/600V DC breaker *
②	≤63A/230V/400V AC breaker
③	32A/230V/400V AC breaker
④	Depends on loads
⑤	Depends on household loads and inverter capacity (Optional)
⑥⑦	30mA RCD (Recommended)
⑧	300mA RCD (Recommended)

Note 1: * If the battery is integrated with a readily accessible internal DC breaker, no additional DC breaker is required.

Note 2: The recommended values in the table are for reference only. The actual values must comply with local standard and actual conditions.

Note 3: The rated current of breaker ② is suggested to lower than that of breaker ⑤.

Note 4: If the rated current of on-site power cables are lower than those recommended above, the breakers specification should be considered to match the power cables in first priority.

Note 5: The AC port takes power from the grid and is set according to the grid circuit breaker.

6.5 External Protective Grounding Connection

DANGER

- There are large currents during the inverter's operation. If the inverter is powered on and put into operation without being grounded, it may lead to electric shock hazards or failures of major protective functions such as surge protection. Therefore, before powering on the inverter, make sure it has been reliably grounded; otherwise, damages caused therefrom will not be covered by warranty.
- When performing electrical connections of the inverter, give the highest priority to grounding. Be sure to carry out the grounding connection first.

WARNING

- Since the inverter is not equipped with a transformer, neither the negative electrode nor the positive electrode of the PV string can be grounded. Otherwise, the inverter will not operate normally.
- Connect the grounding terminal to the external protective grounding point before AC cable connection, PV string connection, and communication cable connection.
- The external protective grounding point provides a reliable ground connection. Do not use an improper grounding conductor for grounding. Otherwise, it may cause product damage or personal injury.
- Depending on Local Rules, please also ground the PV panel subconstruction to the same common grounding point (PE Bar) in addition to local lightning protection rules.

WARNING

The external protective grounding terminal must meet at least one of the following requirements.

- The cross-sectional area of the grounding cable is not less than 10 mm² for copper wire or 16 mm² for aluminum wire. It is recommended that both the external protective grounding terminal and the AC side grounding terminal be reliably grounded.
- If the cross-sectional area of the grounding cable is less than 10 mm² for copper wire or 16 mm² for aluminum wire, ensure that both the external protective grounding terminal and the AC side grounding terminal are reliably grounded.

The grounding connection can be made by other means if they are in accordance with the local standards and regulations, and SUNGROW shall not be held liable for the possible consequences.

6.5.1 External Protective Grounding Requirements

All non-current carrying metal parts and device enclosures in the PV power system should be grounded, for example, brackets of PV modules and inverter enclosure.

When there is only one inverter in the PV system, connect the external protective grounding cable to a nearby grounding point.

When there are multiple inverters in the PV system, connect the external protective grounding terminals of all inverters and the grounding points of the PV module brackets to ensure equipotential connections to ground cables (according to the onsite conditions).

6.5.2 Connection Procedure

External grounding cable and OT/DT terminal are prepared by customers.

step 1 Prepare the cable and OT/DT terminal.

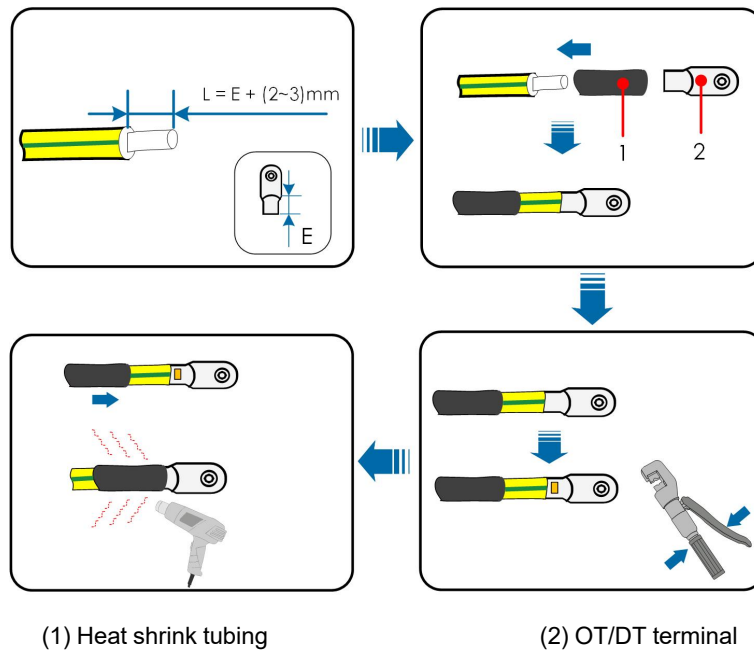

After being crimped, the OT terminal must wrap the wires completely, and the wires must contact the OT terminal closely.

When using a heat gun, protect the device from being scorched.

step 2 Remove the screw on the grounding terminal and fasten the cable with a screwdriver.

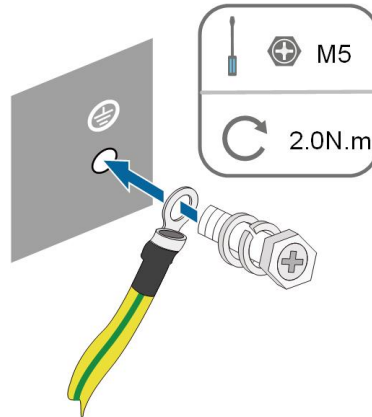

S000-E080

step 3 Apply paint to the grounding terminal to ensure corrosion resistance.

-- End

6.6 AC Cable Connection

6.6.1 AC Side Requirements



Only with the permission of the local grid department, the inverter can be connected to the grid.

Before connecting the inverter to the grid, ensure the grid voltage and frequency comply with requirements, for which, refer to "**Technical Data**". Otherwise, contact the electric power company for help.

AC Circuit Breaker

An independent two-pole circuit breaker must be installed on the output side of the inverter to ensure safe disconnection from the grid. The recommended specifications are as follows.

Inverter Model	Recommended Specification (back-up)	Recommended Specification (on-grid)
SH3.0/3.6/4.0/5.0/6.0RS	32 A	≤ 63 A

NOTICE

Testing to AS/NNZS 4777.2:2020 Section for multiple phase combinations has not been conducted.

WARNING

AC circuit breakers should be installed on the output side of the inverter and the grid side to ensure safe disconnection from the grid.

- **Determine whether an AC circuit breaker with greater overcurrent capacity is required based on actual conditions.**
- **Do not connect any local load between the inverter and the AC circuit breaker.**
- **Multiple inverters cannot share one AC circuit breaker.**

Residual Current Monitoring Device

With an integrated universal current-sensitive residual current monitoring unit included, the inverter will disconnect immediately from the mains power once a fault current with a value exceeding the limit is detected.

However if an external residual current device (RCD) (type A is recommended) is mandatory, the switch must be triggered at a residual current of 300 mA (recommended). RCD of other specifications can also be used according to local standard.

6.6.2 Connecting the AC Cable

step 1 Disconnect the AC circuit breaker and secure it against reconnection.

step 2 Unscrew the swivel nut and take out the sealing ring.

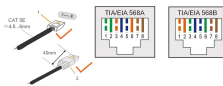

step 3 Thread the AC cable through the swivel nut, appropriate sealing and waterproof cover in sequence.

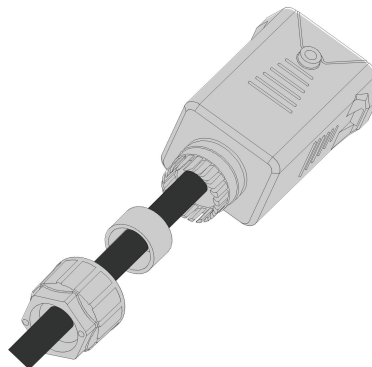

S006-E006

step 4 Strip the cable jacket and the wire insulation as shown in the following figure.

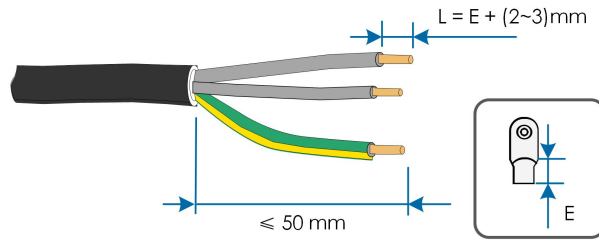

S006-E007

step 5 Crimp the OT/DT terminal.

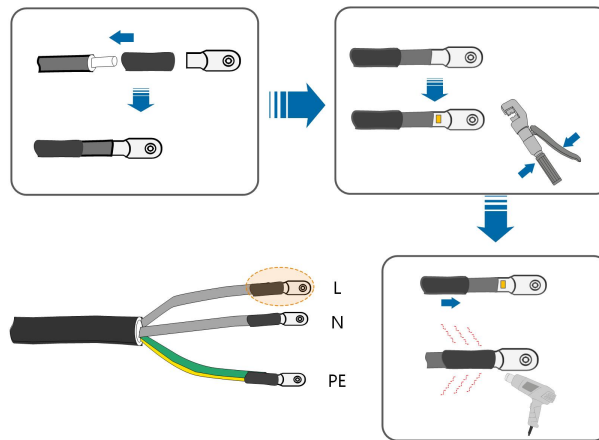

S006-E008

step 6 Remove the waterproof lid from the **GRID** terminal.

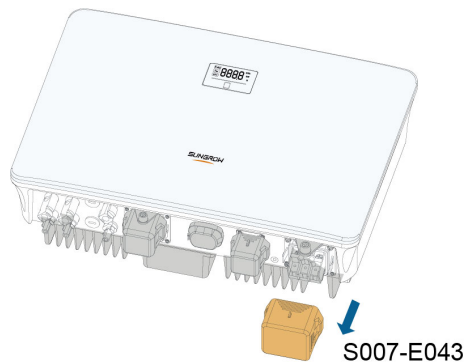

step 7 Fix all the wires to the terminals according to the assignment and tighten to a torque of 2.0 N•m with a screwdriver.

NOTICE

Observe the terminal assignment. Do not connect any phase line to the "PE" terminal or PE wire to "N" terminal. Otherwise, unrecoverable damage to the inverter may follow.

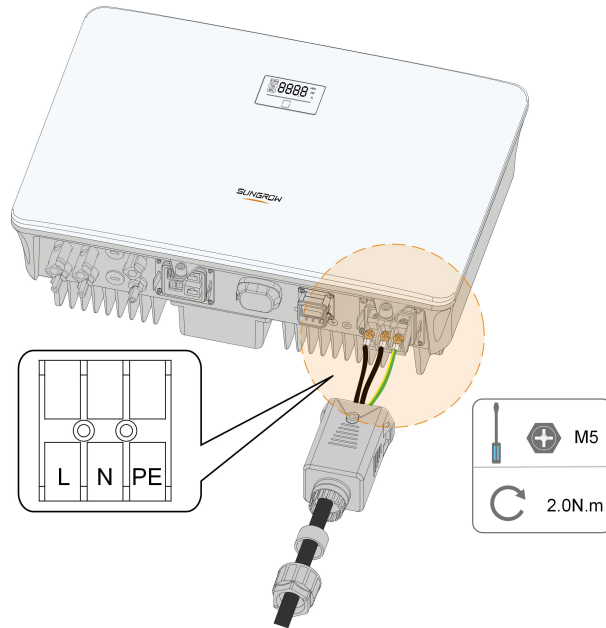

step 8 Secure the AC waterproof cover to the inverter with a torque of 1.2 N•m and tighten the swivel nut to a torque of 5 N•m–6 N•m.

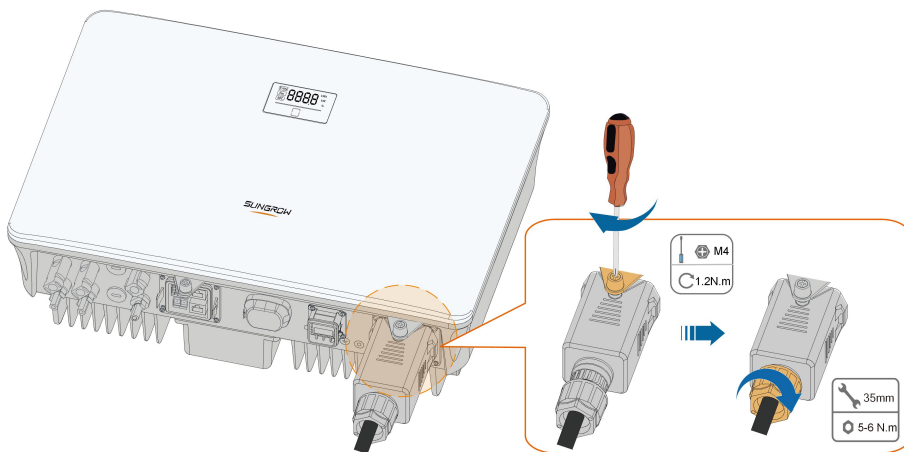

step 9 Connect the PE wire to ground and the phase lines and the “N” line to AC circuit breaker. Then connect the AC circuit breaker to electric board.

step 10 Make sure all wires are firmly installed via the right torque tool or dragging the cables slightly.

-- End

6.7 DC Cable Connection

DANGER

The PV string will generate lethal high voltage when exposed to sunlight.

- Respect all safety instructions listed in relevant documents about PV strings.

WARNING

- Make sure the PV array is well insulated to ground before connecting it to the inverter.
- Make sure the maximum DC voltage and the maximum short circuit current of any string never exceed inverter permitted values specified in "Technical Data".
- Check the positive and negative polarity of the PV strings, and connect the PV connectors to corresponding terminals only after ensuring polarity correctness.
- During the installation and operation of the inverter, please ensure that the positive or negative electrodes of PV strings do not short-circuit to the ground. Otherwise, an AC or DC short-circuit may occur, resulting in equipment damage. The damage caused by this is not covered by the warranty.
- Electric arc or contactor over-temperature may occur if the DC connectors are not firmly in place, and the loss caused is not covered by the warranty.
- If the DC input cables are reversely connected or the positive and negative terminals of different MPPT are shorted to ground at the same time, while the DC switch is in the "ON" position, do not operate immediately. Otherwise, the inverter may be damaged. Please turn the DC switch to "OFF" and remove the DC connector to adjust the polarity of the strings when the string current is lower than 0.5 A.
- Use the DC connectors supplied with the product for DC cable connection. Using incompatible DC connectors may result in serious consequences, and the device damage is not covered under warranty.
- Inverters do not support full parallel connection of strings (Full parallel connection refers to a connection method in that strings are connected in parallel and then connected to the inverter separately).
- Do not connect one PV string to multiple inverters. Otherwise, the inverters may be damaged.

NOTICE

The following requirements about PV string connection must be met. Otherwise, it may cause irreversible damage to the inverter, which is not covered by the warranty.

- **Mixed use of PV modules of different brands or models in one MPPT circuit, or PV modules of different orientation or inclination in a string may not damage inverter, but will cause system bad performance!**
- **The inverter enters standby state when the input voltage ranges between 560 V and 600 V. The inverter returns to running state once the voltage returns to the MPPT operating voltage range, namely, 40 V to 560 V.**

NOTICE

Note the following items when laying out cables on site:

- **The axial tension on PV connectors must not exceed 80 N. Avoid axial cable stress on the connector for a long time during field wiring.**
- **Radial stress or torque must not be generated on PV connectors. It may cause the connector waterproof failure and reduce connector reliability.**
- **Leave at least 50 mm of slack to avoid the external force generated by the cable bending affecting the waterproof performance.**
- **Refer to the specifications provided by the cable manufacturer for the minimum cable bending radius. If the required bending radius is less than 50 mm, reserve a bending radius of 50 mm. If the required bending radius is greater than 50 mm, reserve the required minimum bending radius during wiring.**

6.7.1 PV Input Configuration

- The inverters have two PV inputs, each with independent MPP tracker. Each DC input area can operate independently.
- The PV strings to two DC input areas may differ from each other, including PV module type, number of PV modules in each string, angle of tilt, and installation orientation.

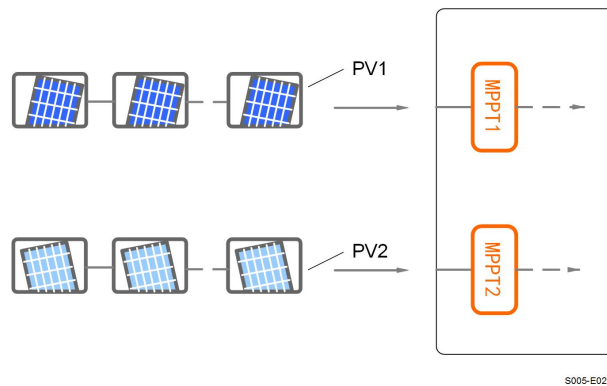

figure 6-3 PV Input Configuration

Prior to connecting the inverter to PV inputs, the following electrical specifications must be met simultaneously:

Inverter Model	Open-circuit Voltage Limit	Max. Current for Input Connector
SH3.0/3.6/4.0/ 5.0/6.0RS	600 V	20 A

6.7.2 Assembling the PV Connectors

⚠ DANGER

High voltage may be present in the inverter!

- Ensure all cables are voltage-free before performing electrical operations.
- Do not connect the DC switch and AC circuit breaker before finishing electrical connection.



To ensure IP65 protection, use only the supplied connector.

step 1 Strip the insulation from each DC cable by 7 mm–8 mm.

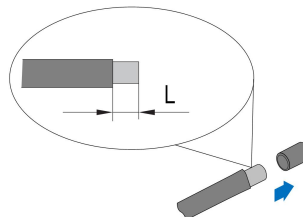

step 2 Assemble the cable ends with the crimping pliers.

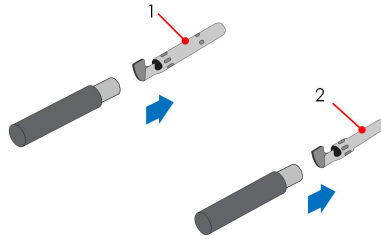

1: Positive crimp contact

2: Negative crimp contact

step 3 Lead the cable through cable gland, and insert the crimp contact into the insulator until it snaps into place. Gently pull the cable backward to ensure firm connection. Tighten the cable gland and the insulator (torque 2.5 N.m to 3 N.m).

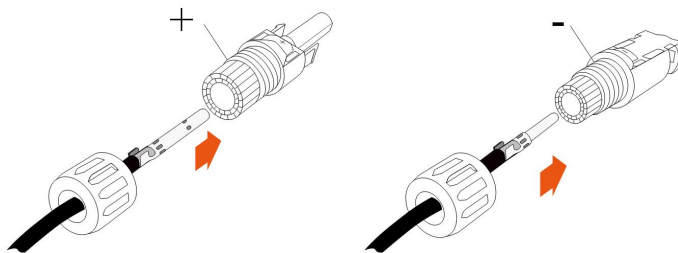

step 4 Check for polarity correctness.

NOTICE

If the PV polarity is reversed, the inverter will be in a fault or alarm state and will not operate normally.

-- End

6.7.3 Installing PV Connector

step 1 Rotate the DC switch to "OFF" position.

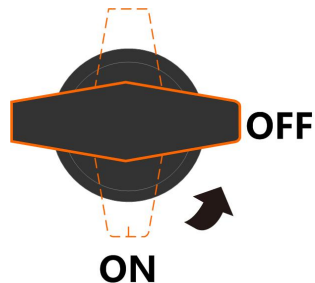

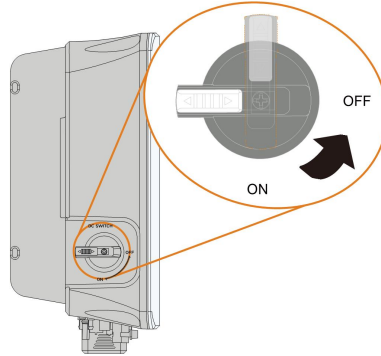

S006-E032

- step 2 Check the cable connection of the PV string for polarity correctness and ensure that the open circuit voltage in any case does not exceed the inverter input limit of 600V.

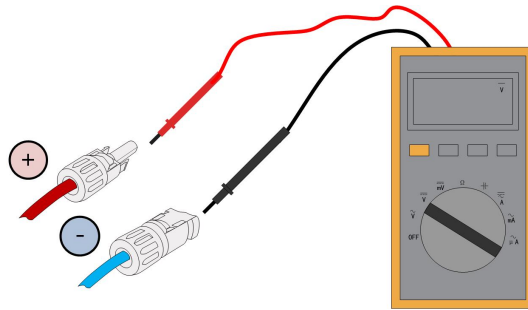

NOTICE

The multimeter must have a DC voltage range of at least 600 V. If the voltage is a negative value, the DC input polarity is incorrect. Please correct the DC input polarity. If the voltage is greater than 600 V, too many PV modules are configured to the same string. Please remove some PV modules.

- step 3 Connect the PV connectors to corresponding terminals until there is an audible click.

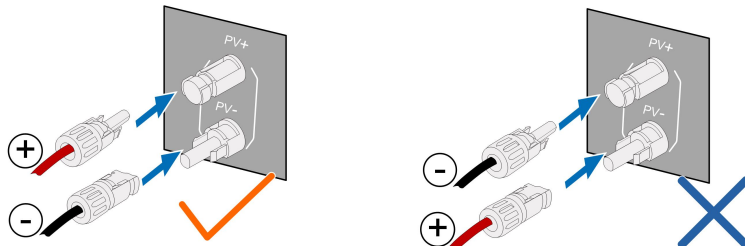

- step 4 Follow the foregoing steps to connect PV connectors of other PV strings.
 step 5 Seal any unused PV terminal with a terminal cap.

SUNGROW inverters cannot be used with third-party optimizers.

If the PV string is equipped with the optimizer, please refer to the optimizer manual for electrical connections and make sure that the polarity of the optimizer cables is correct.

- step 6 Connect the PV+ and PV- of the optimizer to the positive and negative terminals in the junction box of the PV module respectively.

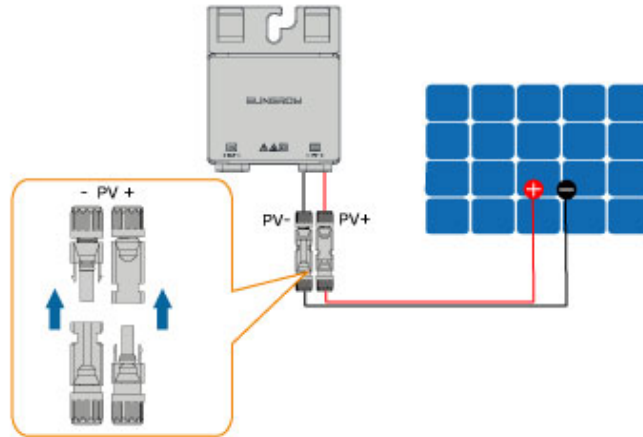

NOTICE

Do not connect the PV module to the OUT+ and OUT- of the optimizer. Otherwise, the optimizer or PV module will be damaged, and the loss is not covered by the warranty.

- step 7 Connect the positive probe of a multimeter to OUT- of the optimizer, and the negative probe of the multimeter to OUT+ of the optimizer to check whether the optimizer is faulty. If typical value of output voltage is 1V, no fault occurs to the optimizer.

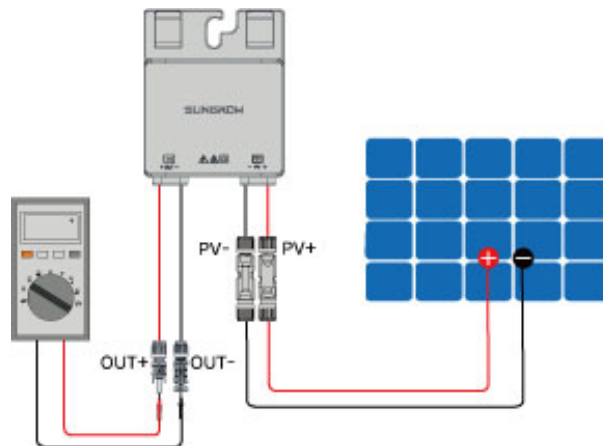

NOTICE

1. Use a multimeter to measure the output voltage of each optimizer after wiring.
2. Considering the effect of the accuracy of the multimeter on the actual measurement on site, the optimizer can function normally as long as the output voltage falls in the range of 0.9V - 1.1V.
3. If the output voltage is less than 0.9 V, check the following items:
 - Check whether the sunlight is sufficient.
 - Check whether the input side of the optimizer is connected to the PV module.
 - If the fault is not caused by foregoing reasons and still persists, please replace the optimizer.
4. If the output voltage is greater than 1.1 V, the optimizer fails. Please replace the optimizer.
5. If no voltage is detected, replace the optimizer or component.

step 8 When connecting multiple optimizers, connect OUT- of the first optimizer to OUT+ of the second optimizer, and so on. Use a multimeter to measure the optimizer voltage. If typical value of output voltage is $1V \cdot N$ (N is the number of optimizers), no fault occurs to the system.

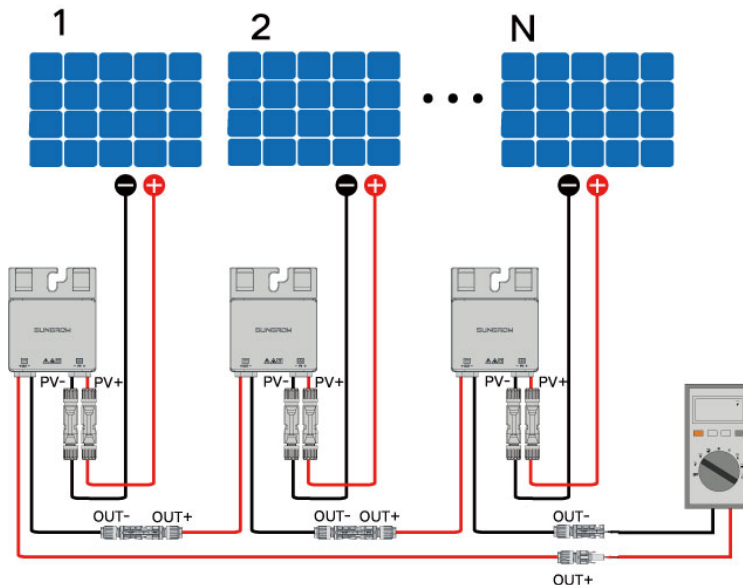

NOTICE

Whether connecting OUT+ of the first optimizer to OUT- of the second optimizer or connecting OUT- of the first optimizer to OUT+ of the second optimizer is dependent on the polarity of the extension cable that is connected to the inverter on site.

step 9 Connect OUT+ of the first optimizer and OUT- of the last optimizer to the PV input terminals of the inverter.

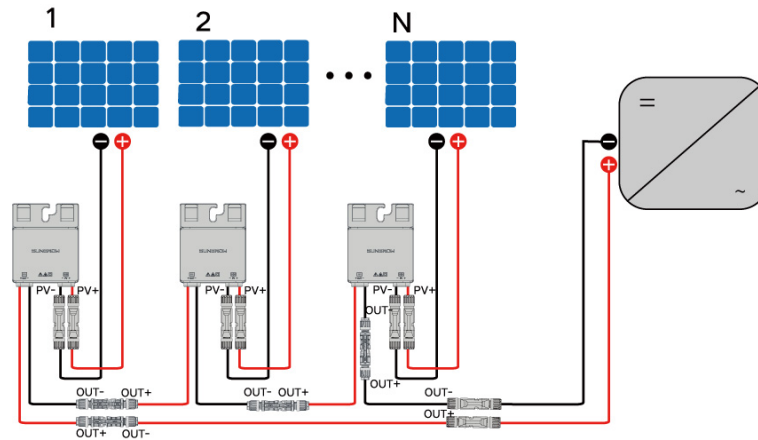

⚠ WARNING

If each PV module is equipped with an optimizer, the total power of PV modules in a PV input shall not exceed the maximum input power of a single PV input of the inverter.

NOTICE

- Branch-connector connection on the input side of the inverter is not supported by the optimizer.
- Please refer to the optimizer user manual for details.



-- End

6.8 Emergency Load Connection (Backup)

NOTICE

Risk of inverter damage due to incorrect cable connection. Do not connect the grid power wires to BACKUP port.



Do not short-circuit the Backup port during operation. Otherwise, the inverter or power distribution system will be seriously damaged. The loss is not covered by the SUNGROW warranty.

- step 1 If no emergency load is connected to the Backup terminal, be sure to insert the Backup connector into the terminal to ensure safety.

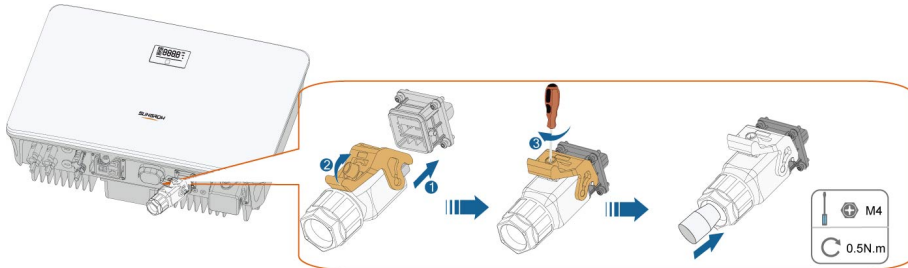

The plug and play connector is not completely sealed in design and thus needs to be sealed off on site using appropriate sealing materials such as sealing mastic and rubber plug.

- step 2 Unscrew the swivel nut of the AC connector.

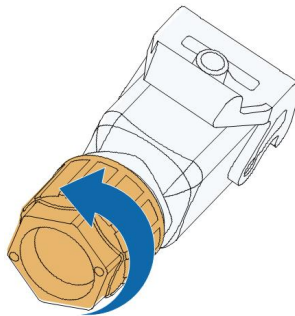

S000-E047

- step 3 Thread the AC cable of appropriate length through the swivel nut, the sealing ring and the housing.

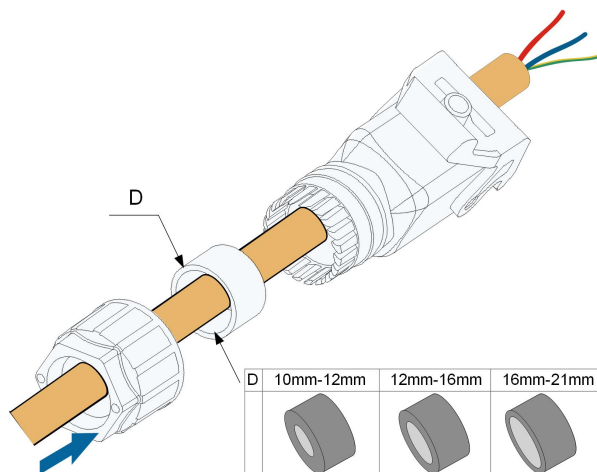

S000-E049

step 4 Remove the cable jacket by less than 45 mm, and strip the wire insulation by 12 mm–16 mm.

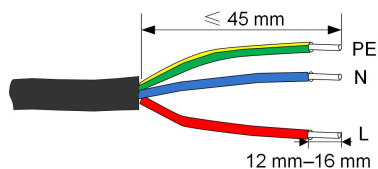

S000-E050

step 5 Open the clamp on the spring-loaded terminal and fully insert the wires into the corresponding holes. Then close the clamp and push the terminal plug into the housing until there is an audible click.

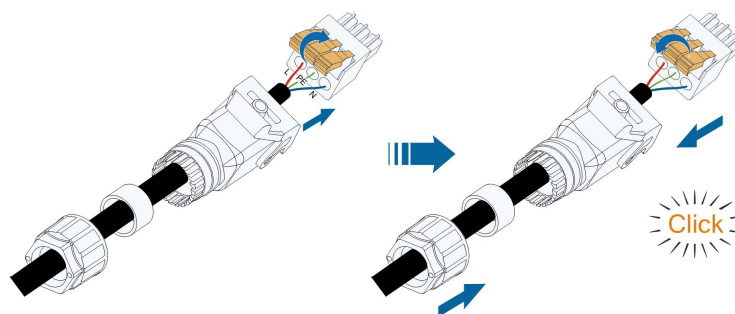

S000-E051

NOTICE

Observe the plug assignment.

- Do not connect the L line to the "PE" terminal or the PE wire to the "N" terminal. Otherwise, unrecoverable damage to the inverter may follow.
- Do not connect the L line and the N line in reverse, otherwise the inverter may not operate normally.

- step 6 Ensure that the wires are securely in place by slightly pulling them. Tighten the swivel nut to the housing.

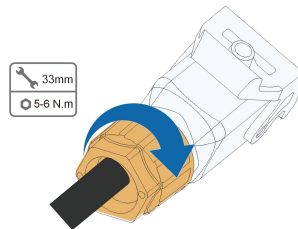

S000-E052

- step 7 Lift the locking part upwards and insert the AC connector into the **BACKUP** terminal on the bottom side of the inverter. Then press the locking part and lock it with the screw.

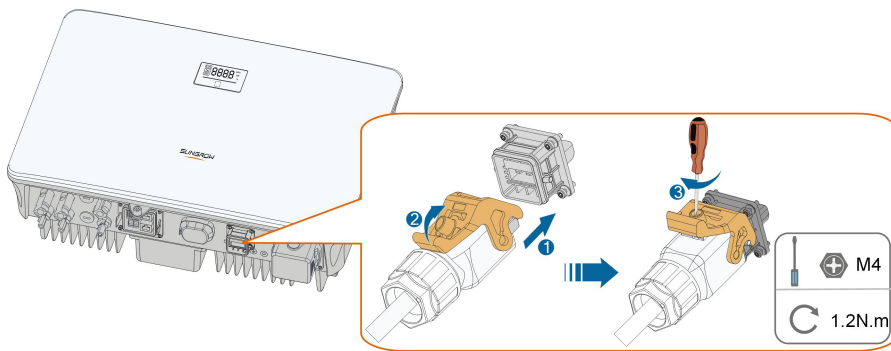

S007-E023

- step 8 Connect the other ends to the emergency loads. Pull all the lines outward lightly to check whether they are firmly installed.

-- End

6.9 Battery Connection

This section mainly describes the cable connections on the inverter side. Refer to the instructions supplied by the battery manufacturer for the connections on the battery side and configuration.

⚠ WARNING

Only use properly insulated tools to prevent accidental electric shock or short circuits. If insulated tools are not available, use electrical tape to cover the entire exposed metal surfaces of the available tools except their tips.

⚠ WARNING

The plug connector must be connected only by trained electricians.

⚠ WARNING

Do not disconnect under load!

Battery connectors must not be disconnected while under load. They can be placed in a no load state by shutting down the inverter completely.

⚠ WARNING

During the installation and operation of the inverter, please ensure that the positive or negative polarities of batteries do not short-circuit to the ground. Otherwise, an AC or DC short-circuit may occur, resulting in equipment damage. The damage caused by this is not covered by the warranty.

If the hybrid inverter is not connected to a battery, it will not support reliably the backup function.



The battery should be connected to the common grounding of the house (PE Bar) rather than directly to the inverter PE.

The energy in the battery will not backfeed into the PV modules.

6.9.1 Connecting the Power Cable

All power cables are equipped with water-proof direct plug-in connectors, which match the battery terminals at the bottom of the inverter.

6.9.1.1 Assembling the Battery Connectors

step 1 Strip the insulation from each DC cable by 15 mm.

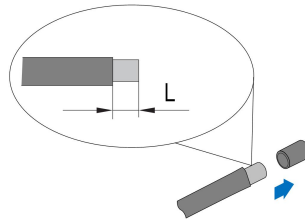

step 2 Assemble the cable ends with the crimping pliers.

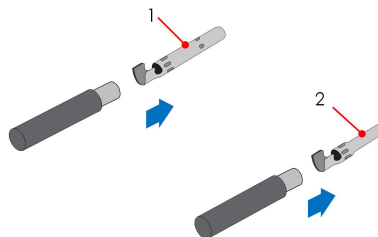

1: Positive crimp contact

2 : Negative crimp contact

step 3 Lead the cable through cable gland, and insert the crimp contact into the insulator until it snaps into place. Gently pull the cable backward to ensure firm connection.

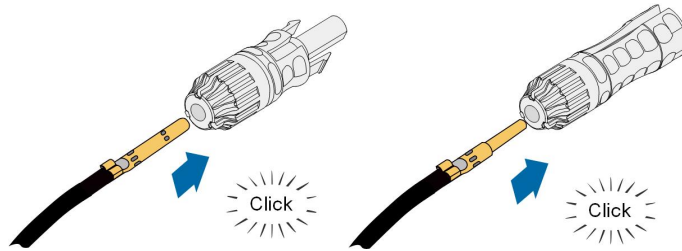

step 4 Tighten the cable gland and the insulator.

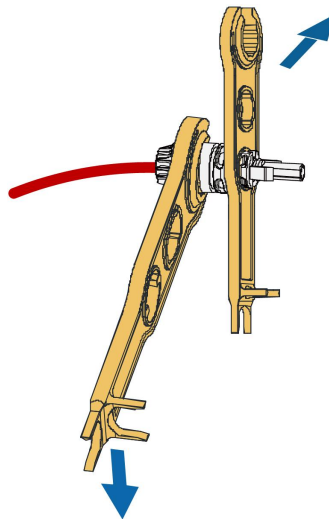

step 5 Check for polarity correctness.

-- End

6.9.1.2 Installing the Battery Connector

NOTICE

When making the connections, always observe the specifications regarding nominal voltage and nominal current. The smallest common value is permissible.

step 1 Plug the connectors into **PV4+/BAT+** and **PV4-/BAT-** terminals.

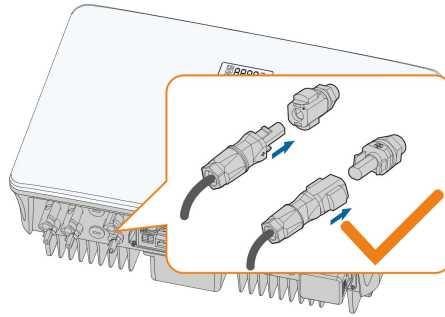

S007-E024

step 2 Ensure that the connectors are securely in place.

-- End

6.9.1.3 Assembling Evo2 Compatible Connector



The connector type is subject to the actual received device.

step 1 Strip 15 mm of the insulation layer from each PV cable.

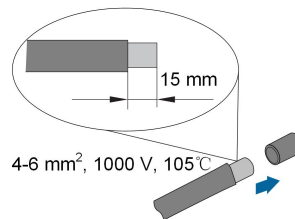

step 2 Unscrew the swivel nut of the connector.

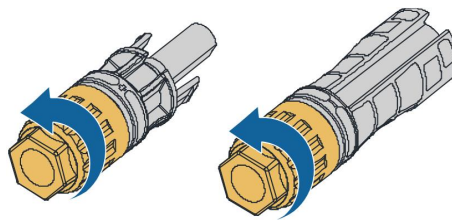

step 3 Lead the stripped cable through the swivel nut and insert it into the insulation sleeve till the end.

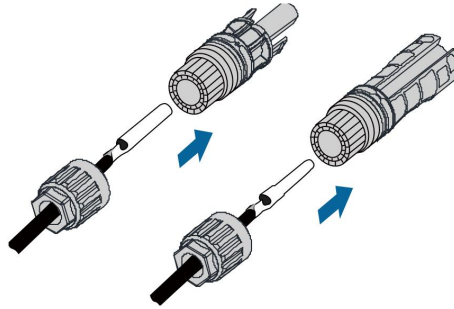

step 4 Screw the swivel nut of the connector and gently pull the cable backward to ensure a firm connection.

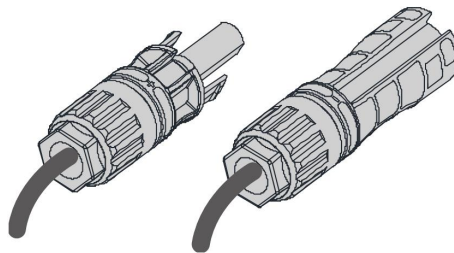

-- End

6.9.1.4 Installing Evo2 Compatible Connector

step 1 Insert the connector into the **BAT+** and **BAT-** terminals.

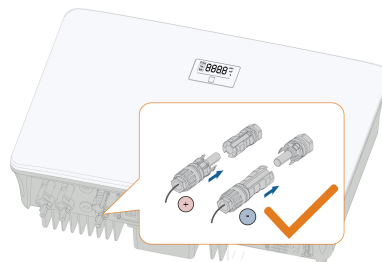

step 2 Check for polarity correctness.

-- End

6.9.2 Connecting the CAN Cable

The CAN cable enables the communication between the inverter and the Li-ion battery from SUNGROW and BYD.

- Pin terminal connection

Refer to the section "[6.11 Meter Connection](#)" for details. Plug the wires into the **H** and **L** terminals according to the labels on the bottom of the inverter.

- RJ45 connection

Refer to the section "[6.13 DRM Connection](#)" for details. Plug the wires into the **RJ45-CAN** terminal on the bottom of the inverter.

6.9.3 Connecting the Enable Cable

The Enable cable along with the RS485 cable, are used for communication between the inverter and the Li-ion battery.

For detailed connection description of the RS485 cable, refer to the section "[6.12 RS485 Connection](#)".

For detailed connection description of the Enable cable, refer to the section "[6.11 Meter Connection](#)". Plug the wires into the **EN_H** and **EN_G** terminals according the labels on the bottom of the inverter.

6.10 WiNet-S Connection

The WiNet-S module supports Ethernet communication and WLAN communication. It is not recommended to use both communication methods at the same time.

For details, see the quick guide for the WiNet-S module. Scan the following QR code for the quick guide.



6.10.1 Ethernet Communication

step 1 **(Optional)** Strip the insulation layer of the communication cable with an Ethernet wire stripper, and lead the corresponding signal cables out. Insert the stripped communication cable into the RJ45 plug in the correct order, and crimp it with a crimper.

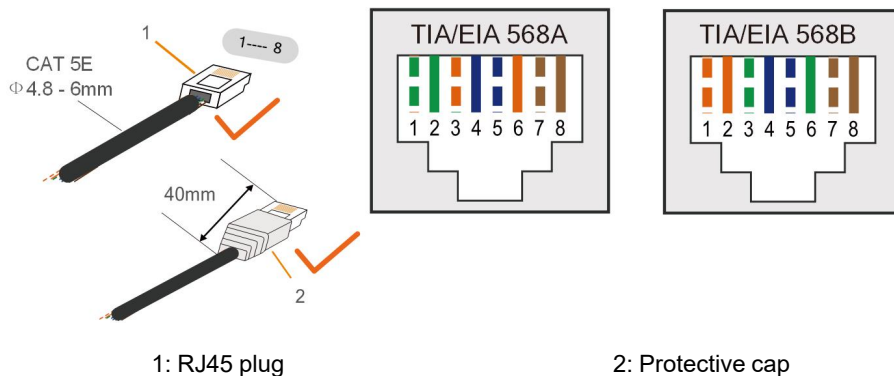

Skip this step if a standard network cable with RJ45 plug is prepared.

step 2 Unscrew the swivel nut from the communication module and take out the inner sealing ring.

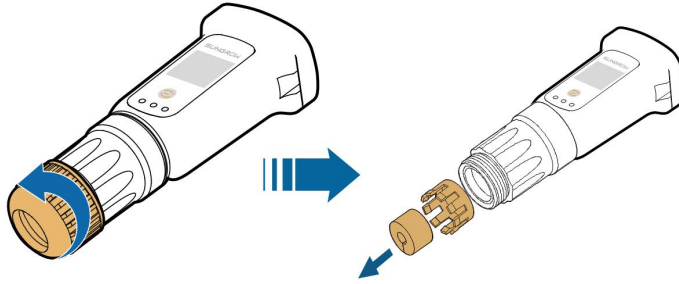

step 3 Unscrew the housing from the communication module.

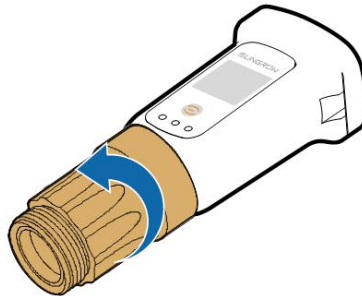

step 4 Thread the network cable through the swivel nut and gasket. Afterwards, route the cable into the opening of the sealing. Finally, insert the cable through the housing.

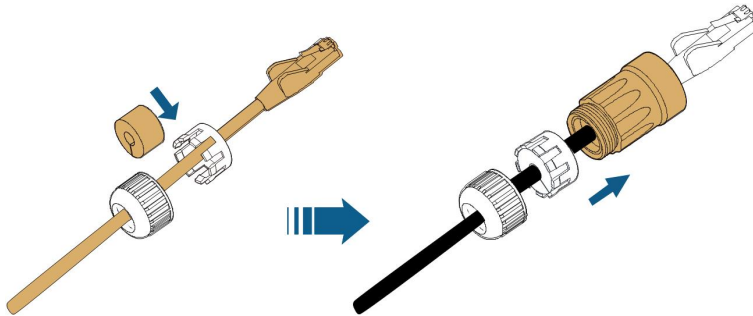

step 5 Insert the RJ45 plug into the front plug connector until there is an audible click and tighten the housing. Install the gasket and fasten the swivel nut.

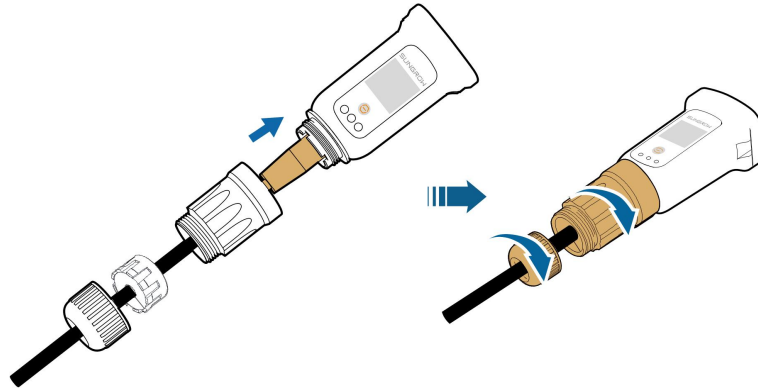

step 6 Remove the waterproof lid from the **COM1** terminal and install WiNet-S2.

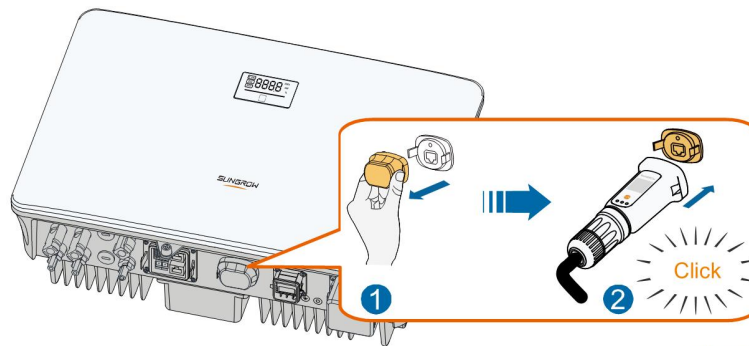

S007-E041

step 7 Slightly shake it by hand to determine whether it is installed firmly.

-- End

6.10.2 WLAN Communication

step 1 Remove the waterproof lid from the **COM1** terminal.

step 2 Install the module. Slightly shake it by hand to determine whether it is installed firmly, as shown below.

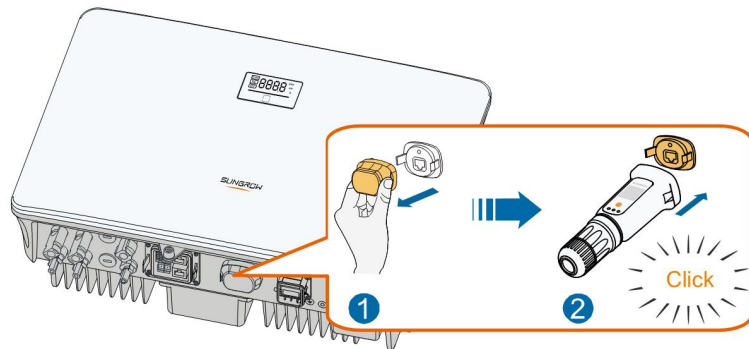

S007-E042

step 3 Refer to the guide delivered with the module for the set-up.

-- End

6.11 Meter Connection

The inverter can provide export control but will require the use of a external smart meter. The export control functionality has not been tested to AS/NZS 4777.2:2020.



The energy meter is mainly used to detect the direction and magnitude of the current. And the energy meter data may not be used for billing purposes.

step 1 Remove the cable jacket and strip the wire insulation.

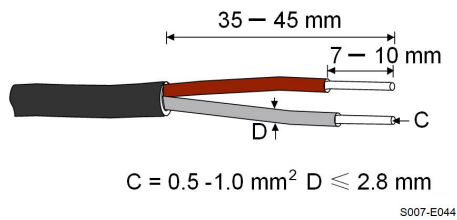

step 2 (Optional) When using a multi-strand wire cable, connect the wire head to the cord end terminal. In case of single-strand copper wire, skip this step.

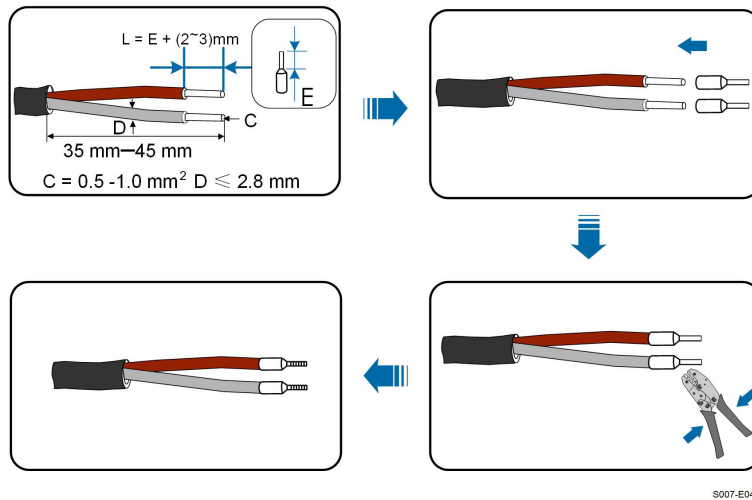

step 3 Unscrew the swivel nut from the connector.

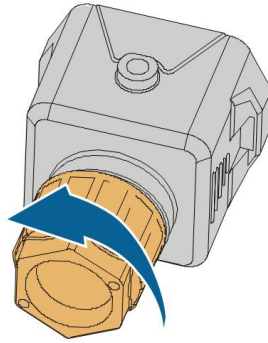

S006-E011

step 4 Remove the seal and route the cable into the opening of the sealing.

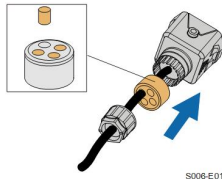

S006-E012

step 5 Plug the wires into the corresponding terminals as shown in the following figure. Ensure that the wires are securely in place by slightly pulling them.

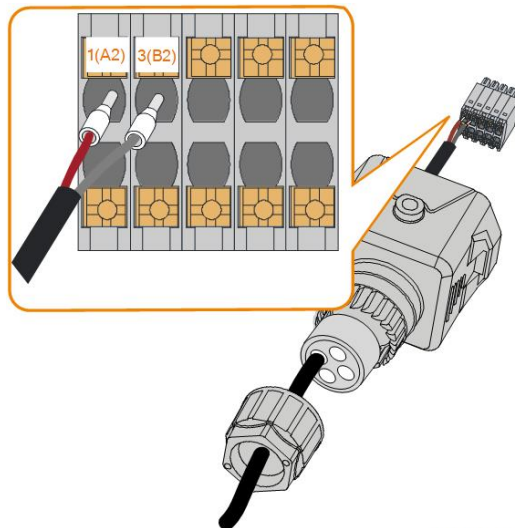

S006-E013

step 6 Remove the waterproof lid from the **COM2** terminal.

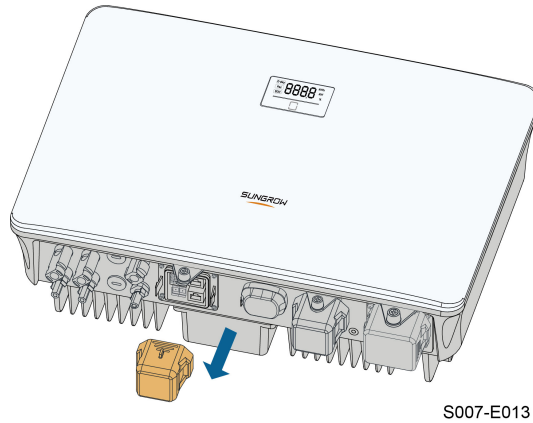

step 7 Insert the terminal plug into the **COM2** terminal at the bottom side of the inverter and then install the housing.

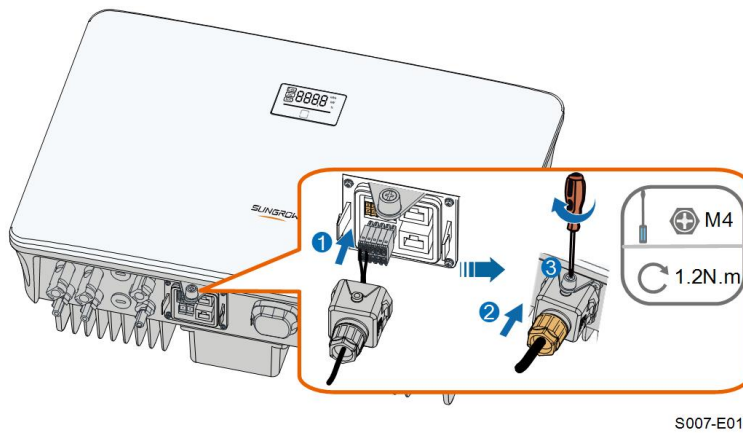

step 8 Slightly pull out the cable and then fasten the swivel nut. Lock the connector with the screw.

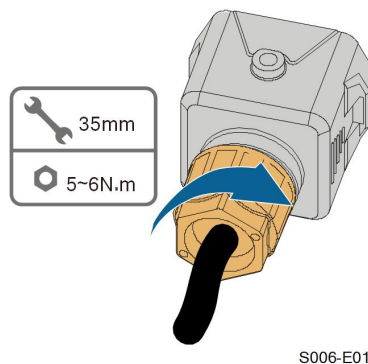

step 9 The other end of the communication cable is connected to the RS485A and RS485B ports of the smart meter.

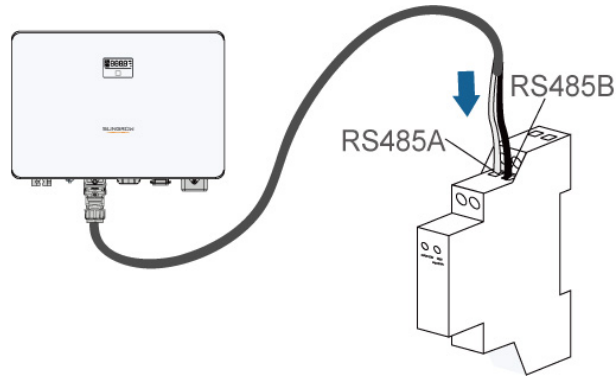

step 10 (Optional) If the length of the communication cable > 10m, please connect a 120Ω resistor in parallel to the meter. Plug the resistor directly into both RS485 communication ports.

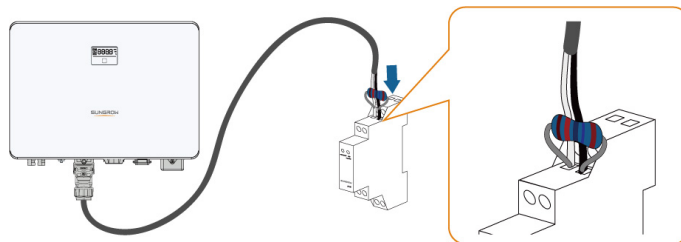

step 11 If the smart energy meter is used, please refer to the following wiring method.

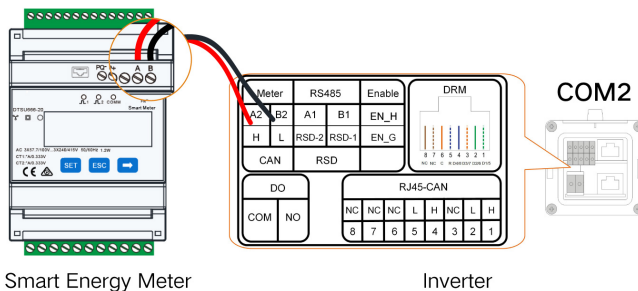

-- End

6.12 RS485 Connection

The RS485 connection is reserved for inverter daisy chain. The availability will be updated in the upcoming manual version.

For detailed connection description, refer to the section "6.11 Meter Connection". Plug the wires into the **A1** and **B1** terminals according to the labels on the bottom of the inverter.

6.13 DRM Connection

DRM and Ripple Control support only one function at the same time.

DRM

In Australia and New Zealand, the inverter supports the demand response modes as specified in the standard AS/NZS 4777.

The following figure shows the wiring between the inverter and the external DRED.

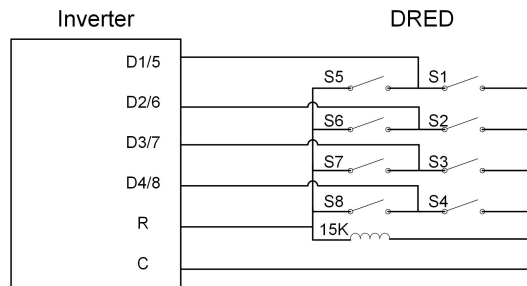

table 6-4 Method of Asserting DRM

Mode	Asserted by Shorting Terminals on Inverter	Switch Operation on External DRED
DRM0	R & C	Close S1 and S5
DRM1	D1/5 & C	Close S1
DRM2	D2/6 & C	Close S2
DRM3	D3/7 & C	Close S3
DRM4	D4/8 & C	Close S4
DRM5	D1/5 & R	Close S5
DRM6	D2/6 & R	Close S6
DRM7	D3/7 & R	Close S7
DRM8	D4/8 & R	Close S8

Ripple Control

In Germany, the grid company uses the Ripple Control Receiver to convert the grid dispatching signal and send it as a dry contact signal.

Wiring of the ripple control receiver dry contact cables is shown in the figure below:

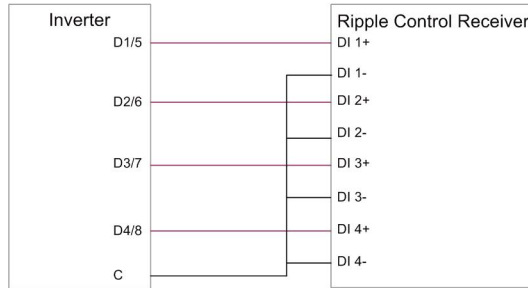

step 1 **(Optional)** Strip the insulation layer of the communication cable with an Ethernet wire stripper, and lead the corresponding signal cables out. Insert the stripped communication cable into the RJ45 plug in the correct order, and crimp it with a crimper.

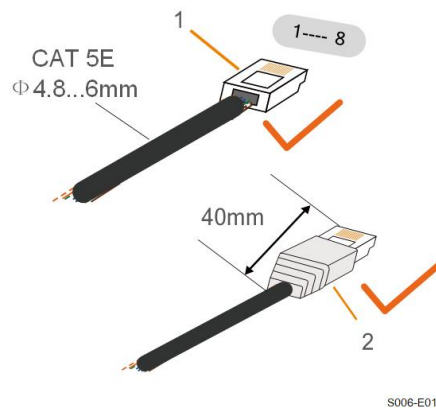

1: RJ45 plug

2 : Protective cap



Skip this step if a standard network cable with RJ45 plug is prepared.

step 2 Unscrew the swivel nut from the connector.

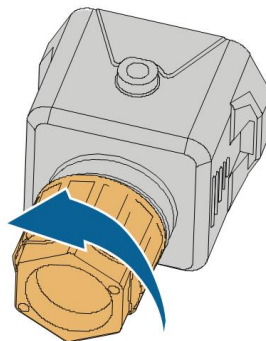

S006-E011

step 3 Remove the seal.

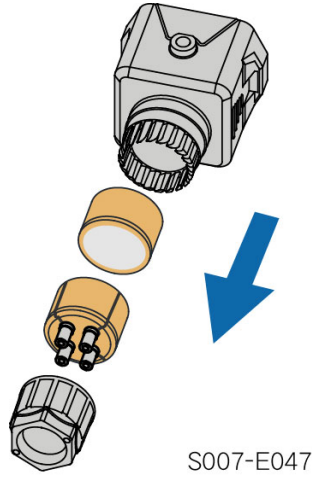

step 4 Lead the cable through the cable gland.

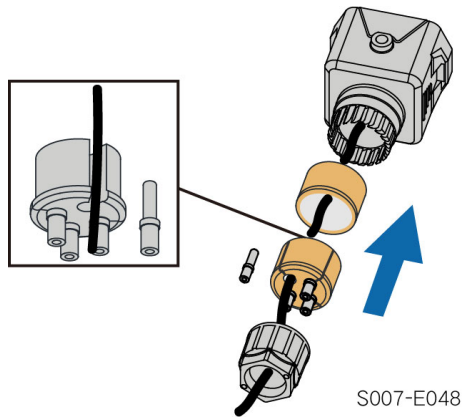

step 5 Plug the wires into the corresponding terminals as shown in the following figure. Ensure that the wires are securely in place by slightly pulling them.

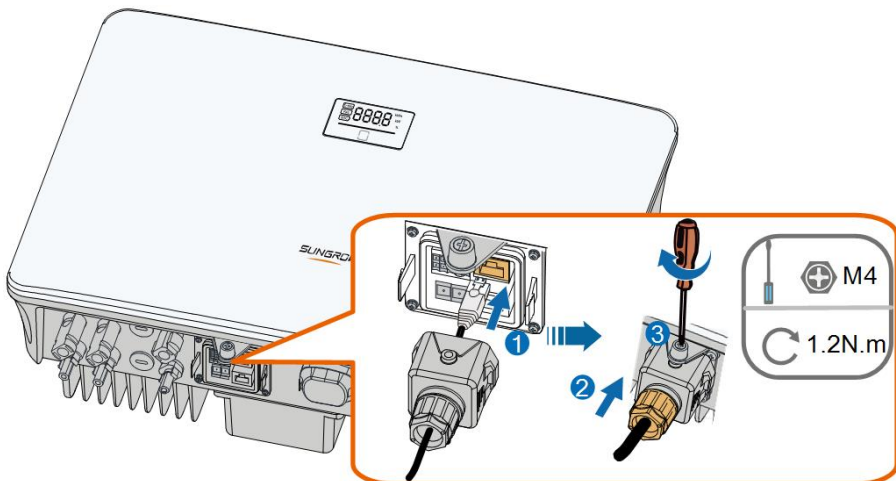

step 6 Slightly pull out the cable and then fasten the swivel nut. Lock the connector with the screw.

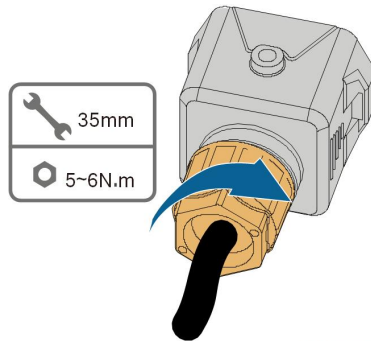

S006-E015

-- End

6.14 EV Charger Communication Connection

For details about the electrical connection of SUNGROW AC007E-01 EV Charger, please refer to its user manual.

Connect the EV Charger to the inverter for communication as follows:

Procedure

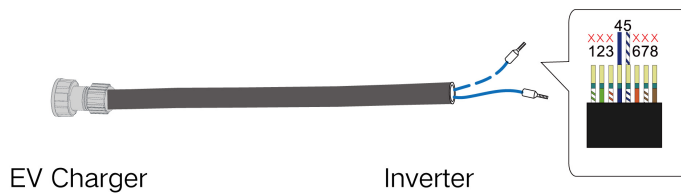

Connect the EV Charger, with RJ45 connector adopted on the EV Charger side, to A1(5) and B1(7) of COM2 on the inverter, and complete the wiring for communication between the EV Charger and inverter.

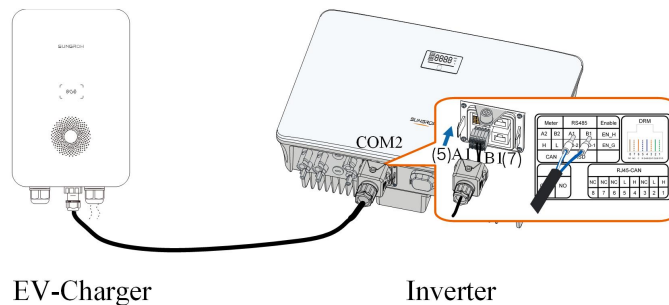

The default port used for EV Charger communication is A1(5) and B1(7) of COM2 on the inverter. If A1 and B1 are already used to connect a battery, connect the EV Charger using the backup communication port A2(1) and B2(3). If the S100 meter shares the A2/B2 port with the EV Charger, it is needed to connect a 120Ω resistor in parallel with the S100 meter. The wiring diagram is shown below:

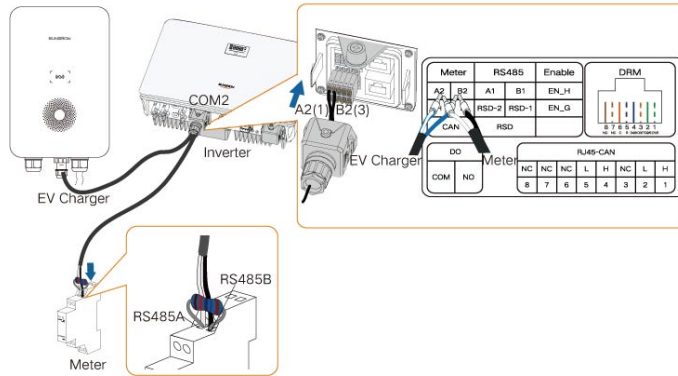

Meanwhile, change the setting of "EV Charger Access Port" on the iSolarCloud App, from RS485-1 to RS485-2. The steps are shown below:

Tap More—>Settings—>Energy Management Parameters—>EV Charger—>EV Charger Access Port—>RS485-2—>Complete

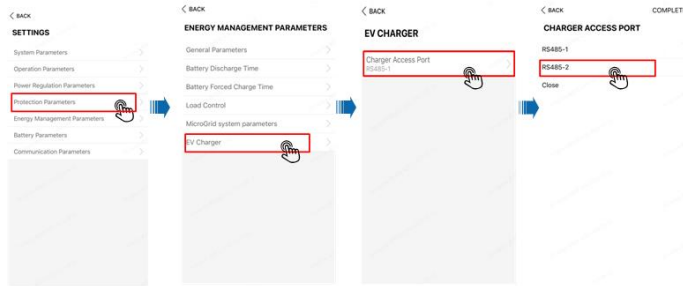

6.15 Protective Cover Installation (Optional)

NOTICE

- Please install the protective cover after finishing all electrical connections of the inverter.

The installation procedure of the protective cover is as follows:

step 1 The protective cover consists of a left cover, a right cover and a top cover.

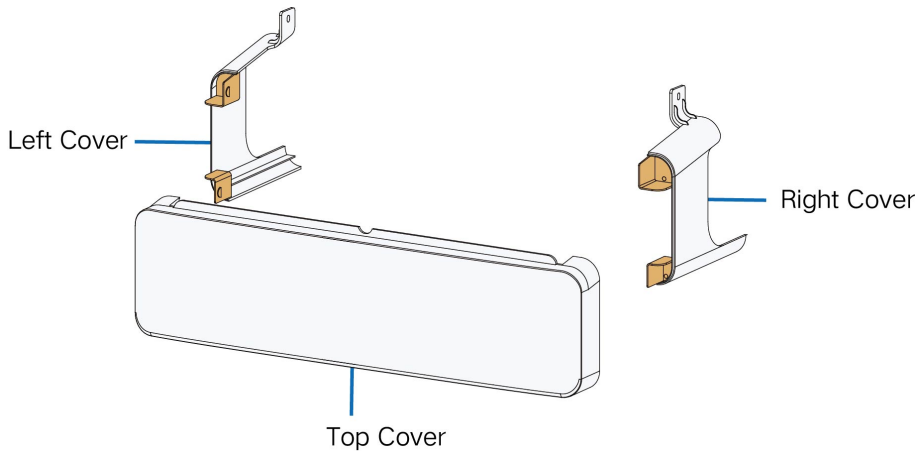

step 2 Slot the left cover and the right cover into the top cover until there is an audible "click".

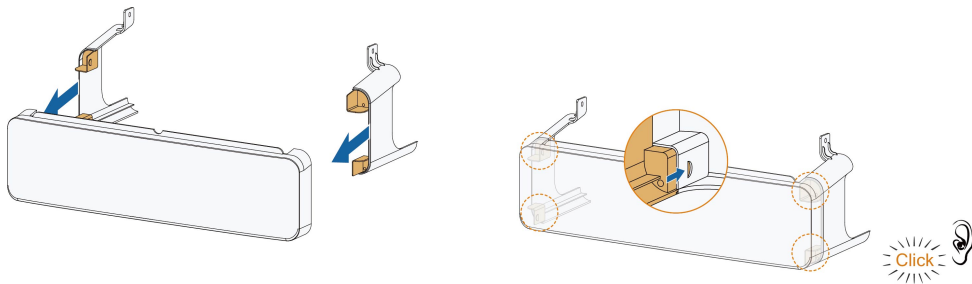

step 3 After the electrical connection of the inverter is completed, install the protective cover to the inverter bottom and make sure that the threaded holes in buckles of the protective cover are aligned with the holes on the sides of the inverter.

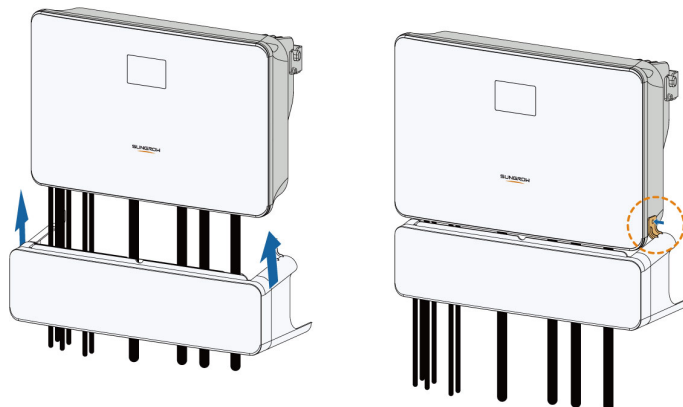

step 4 Use a screwdriver to secure screws with a torque of 1.5 N.m.

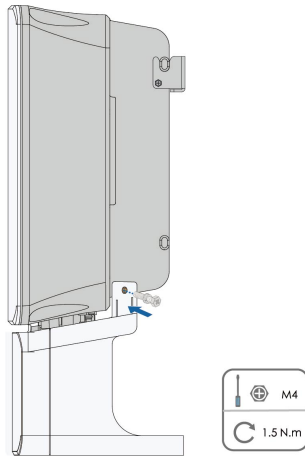

step 5 The installation of the protective cover is completed.

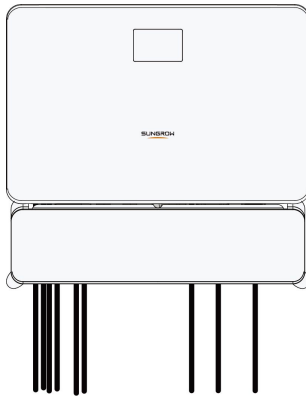

-- End

7 Commissioning

7.1 Inspection Before Commissioning

Check the following items before starting the inverter:

- All equipment has been reliably installed.
- DC switch(es) and AC circuit breaker are in the "OFF" position.
- The ground cable is properly and reliably connected.
- The AC cable is properly and reliably connected.
- The DC cable is properly and reliably connected.
- The communication cable is properly and reliably connected.
- The vacant terminals are sealed.
- No foreign items, such as tools, are left on the top of the machine or in the junction box (if there is).
- The AC circuit breaker is selected in accordance with the requirements of this manual and local standards.
- All warning signs & labels are intact and legible.

7.2 Powering on the System

If all of the items mentioned above meet the requirements, proceed as follows to start up the inverter for the first time.

- step 1 Turn on the AC circuit breaker between the inverter and the grid.
- step 2 (Optional) Connect the external DC circuit breaker between the inverter and the battery pack if a battery is equipped.
- step 3 (Optional) Power on the battery pack manually if a battery is equipped.
- step 4 Rotate the DC switch of the inverter to "ON" position.
- step 5 If the irradiation and grid conditions meet requirements, the inverter will operate normally. Observe the LED indicator to ensure that the inverter operates normally. Refer to ["2.4 LED Panel"](#) for LED screen introduction and LED indicator definition.
- step 6 Refer to the quick guide for WiNet-S for its indicator definition.

-- End



- Strictly follow the preceding sequence. Otherwise, the product may be damaged, and the loss caused is not covered by the warranty.
- Before closing the AC circuit breaker between the inverter and the power grid, use a multimeter that is set to the AC gear to ensure that the AC voltage is within the specified range. Otherwise, the inverter may be damaged.

7.3 App Preparation

step 1 Install the iSolarCloud App with latest version. Refer to "[8.2 Installing App](#)".

step 2 Register an account. Refer to "[8.3 Account Registration](#)". If you have got the account and password from the distributor/installer or SUNGROW, skip this step.

step 3 Download the firmware package to the mobile device in advance. Refer to "Firmware Update". This is to avoid download failure due to poor on-site network signal.

-- End

7.4 Plant Creation

Prerequisites:

- The account and password for logging in to iSolarCloud App have been obtained from the distributor/installer or SUNGROW.
- The communication device is normally connected to the inverter.
- System positioning is enabled and iSolarCloud App is allowed to access location information.

step 1 Open the App, tap **More** in the upper right corner of the interface, and select the correct access address.

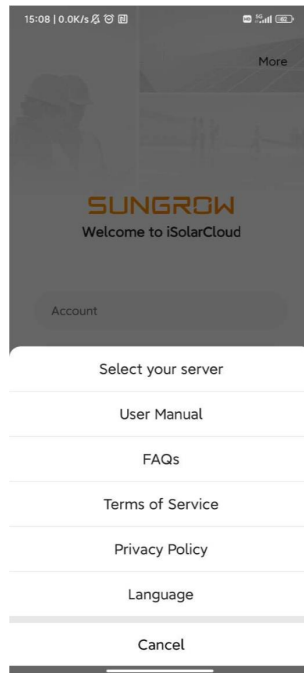
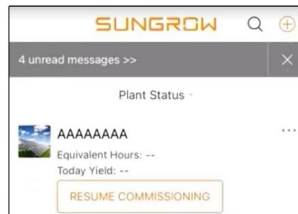

figure 7-1 Select Access Address

step 2 Enter the account and password on the login interface, and tap **LOGIN** to log in.

step 3 Tap  in the upper right corner to enter the plant creation interface.



step 4 Fill in the content according to actual needs, and the parameters containing * are required. Tap **Next** to enter the next interface.

figure 7-2 Plant Creation Settings

Parameter Name	Description
Plant name	The name of the plant.
Plant type	The type of the plant, which should be set corresponding to the actual plant type.
Installed power	The installed power of the plant.
Country/Region	The country/region where the plant is located.
Time zone	The time zone where the plant is located, which can be filled through automatic positioning and manual input.
Plant address	<p>The location of the plant, which can be filled in two ways:</p> <ul style="list-style-type: none"> Manually: Manually enter the plant location in the input box. Automatically: Tap  to automatically obtain the current location or search for the location of the plant, and then tap Confirm.

Parameter Name	Description
Grid-connection type	The way the plant is connected to the grid, including 100% Feed-in, Self-Consumption, Zero Export, and Off-grid.
Grid-connected date	The time when the plant is connected to the grid.
Owner's email address	Fill in the owner information of the plant, and both registered and un-registered email addresses are supported.
Postal code	The postal code of the place where the plant is located.
Plant image	Take photos of the plant and upload them.
Feed-in tariff	<p>The feed-in tariff can be set in two ways:</p> <ul style="list-style-type: none"> • Enter the feed-in tariff directly in the input box. • Tap More Configurations, select the tariff unit, enter the feed-in tariff, and tap Confirm. Enable Time-of-Use Tariff if needed. Tap Add Time-of-Use Tariff, add time intervals and price, and tap Confirm. Please note that if Time-of-use Tariff is enabled, the time periods shall cover 24 hours a day, and can not overlap.
Consumption tariff	<p>Set the consumption tariff as follows:</p> <ul style="list-style-type: none"> • Tap More Configurations, select the tariff unit, enter the consumption tariff, and tap Confirm. Enable Time-of-Use Tariff if needed, and refer to the setting methods of the feed-in tariff.

- step 5 Bind a device through scanning the QR code on the device, manually inputting the device S/N, or uploading a QR code picture. Tap **Confirm** after the QR code is identified or the S/N is verified.

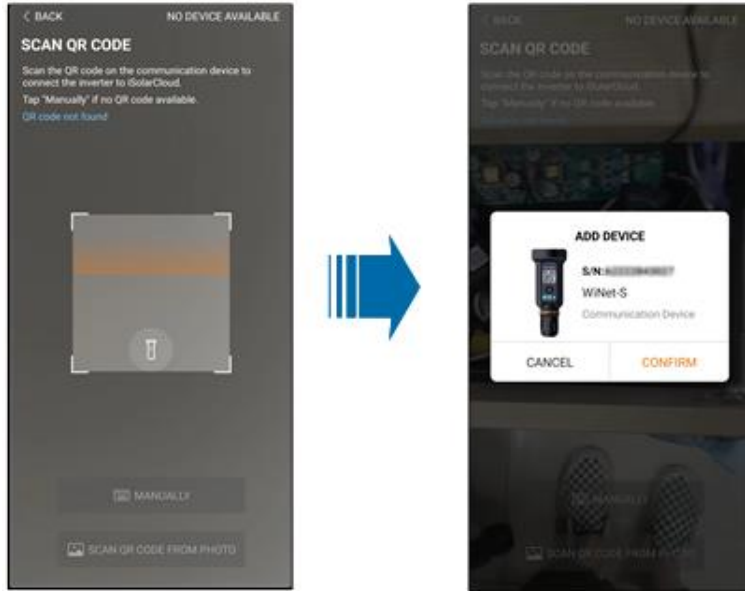

step 6 After a device is bound, tap **Device** and **Commissioning** to go to corresponding interface.

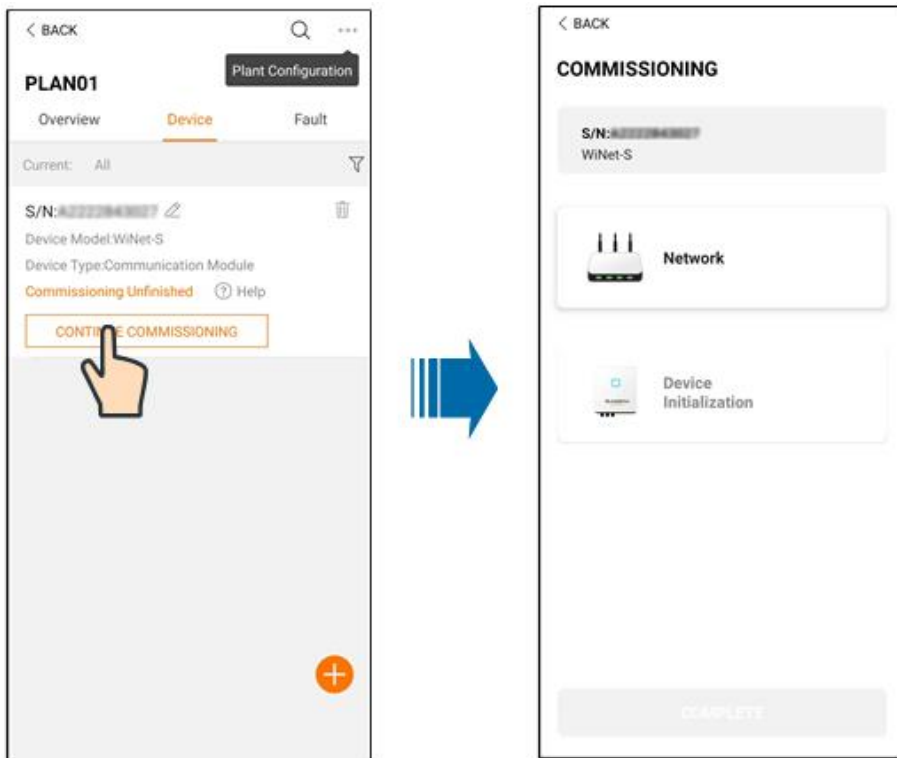

step 7 Tap **Network Configuration** to go to the **WLAN connection** interface. Tap the home network in the WLAN list, enter the password, and then tap **Confirm**.

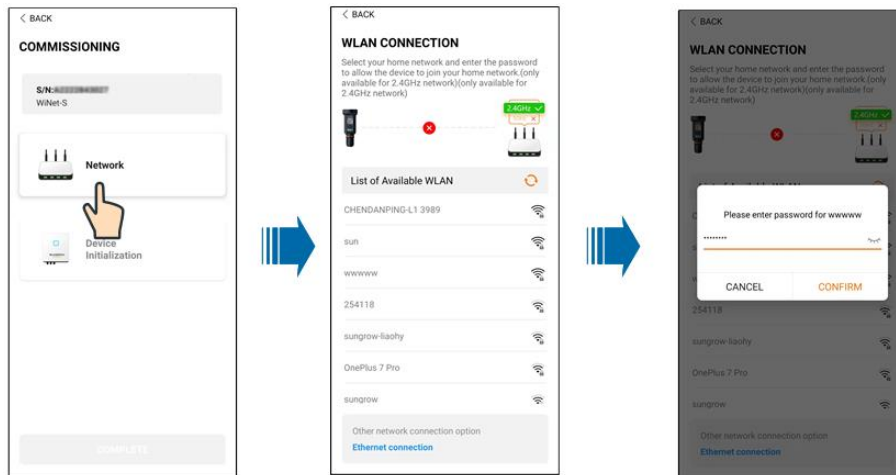

- step 8 Enter the **Activate EasyConnect** interface, and press the multi-function button on the WiNet-S to enable the Easyconnect mode according to the prompt on the screen. The App automatically enters a waiting processing interface if this mode is enabled, and automatically returns to the commissioning interface after the processing is completed.

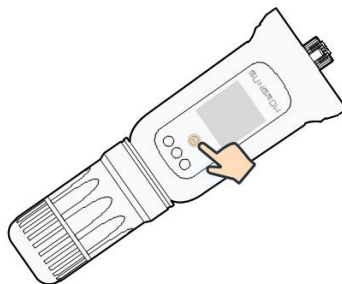

NOTICE

Only the 2.4 GHz working band is supported under the networking mode.
If the Easyconnect fails, please refer to other methods in the WiNet-S manual to establish the connection.

- step 9 Tap **Device Initialization** to go to the **Device initialization** interface. Set the initialization protection parameters as needed and tap **Settings** to return to the commissioning interface.

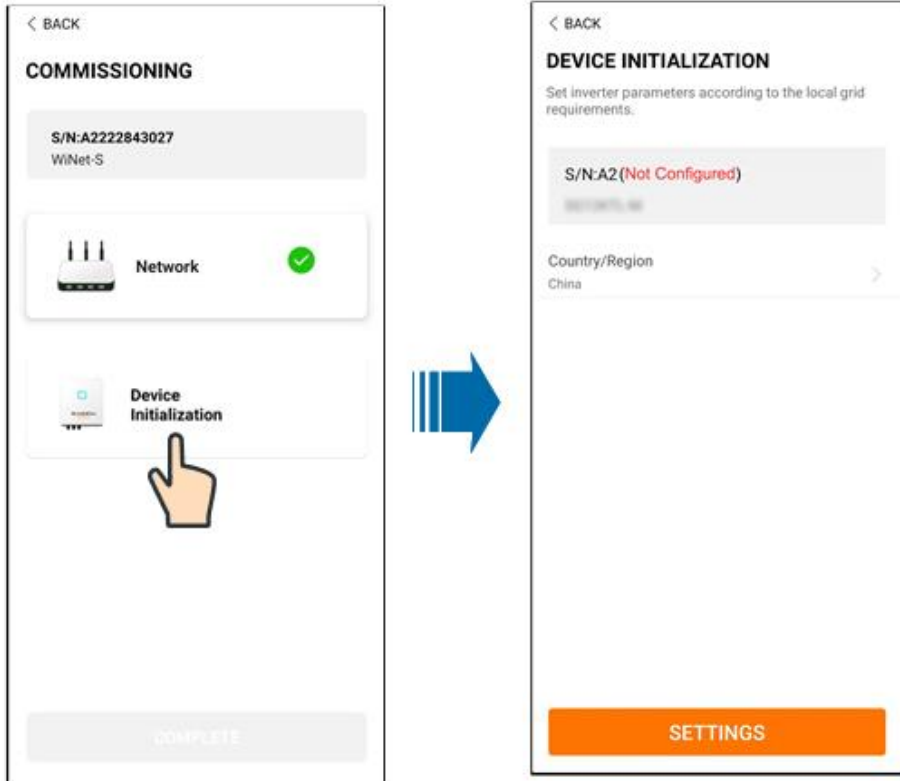

When the country is set to Australia, additionally set the applicable network service provider and then the grid type.

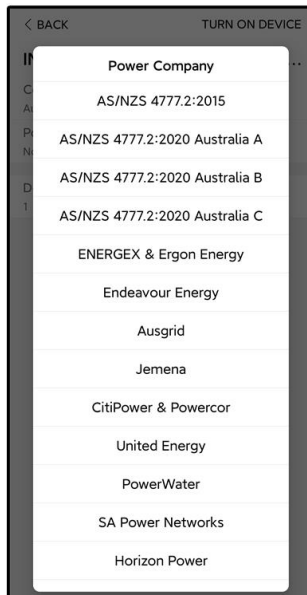

The image shown here is for reference only. Refer to the actual interface for the supported network service providers.

table 7-1 Description of Network Service Provider and Grid Type

Network Service Provider	Grid Type
AS/NZS 4777.2:2015	/
AS/NZS 4777.2:2020	/
Australia A	/
AS/NZS 4777.2:2020	/
Australia B	/
AS/NZS 4777.2:2020	/
Australia C	/
ENERGEX & Ergon Energy	<ul style="list-style-type: none"> • STNW1170: single-phase < 10 kVA & three-phase < 30 kVA • STNW1174: 30 kVA < $P_n \leq 1500$ kVA
Jemena	<ul style="list-style-type: none"> • ≤ 10 kVA per phase (or 30 kVA per three phase) • ELE GU 0014: 30 kVA–200 kVA
Endeavour Energy	MDI 0043
Ausgrid	NS194
CitiPower & Powercor	<ul style="list-style-type: none"> • ≤ 5 kVA for single-phase & 30 kVA for three-phase • > 30 kVA three-phase
United Energy	<ul style="list-style-type: none"> • UE-ST-2008.1: ≤ 10 kVA for single-phase & 30 kVA for three-phase • UE-ST-2008.2: > 30 kVA three-phase
PowerWater	Embedded Generation Notice Photovoltaic Systems:2020
SA Power Networks	<ul style="list-style-type: none"> • TS129-2019: < 10 kW for single-phase & 30 kW for three-phase • TS130-2017: > 30 kW & ≤ 200 kW • TS131-2018: > 200 kW
Horizon Power	<ul style="list-style-type: none"> • HPC-9DJ-13-0001-2019: ≤ 10kVA for single-phase & 30 kVA for three-phase • HPC-9DJ-13-0002-2019: > 30kVA & ≤ 1MVA
westernpower	EDM#33612889-2019
AusNet Services	Basic Micro Embedded Generation: 2020

* For compliance with AS/NZS 4777.2:2020, please select from Australia A/B/C. Please contact your electricity grid operator for which region to use.



- Please check the country supported by this product at [http:// support.sungrow-power.com/](http://support.sungrow-power.com/).
- Set **Country/Region** to the country/region where the inverter is installed. Otherwise, the inverter may report a fault.
- For the commissioning process – country code must be selected before the inverter can operate.

step 10 After a plant is successfully created, return to the App home page to view the plant information.

-- End

8 iSolarCloud App

8.1 Brief Introduction

The iSolarCloud App can establish communication connection to the inverter via the WLAN, providing remote monitoring, data logging and near-end maintenance on the inverter. Users can also view inverter information and set parameters through the App.

To achieve direct login via WLAN, the wireless communication module developed and manufactured by SUNGROW is required. The iSolarCloud App can also establish communication connection to the inverter via Ethernet connection.



- This manual describes only how to achieve near-end maintenance via WLAN direct connection.
- Screenshots in this manual are based on the V2.1.6 App for Android system, and the actual interfaces may differ.

8.2 Installing App

Method 1

Download and install the App through the following application stores:

- MyApp (Android, mainland China users)
- Google Play (Android, users other than mainland China ones)
- App Store (iOS)

Method 2

Scan the following QR code to download and install the App according to the prompt information.



The App icon appears on the home screen after installation.



8.3 Account Registration

The account distinguishes two user groups, owners and retailer/installer.

- The owner can view plant information, create plants, set parameters, share plants, etc.
- The retailer/installer can help the owner to create plants, manage, install, or maintain plants, and manage users and organizations.

step 1 Tap **REGISTER** to enter the registration screen.

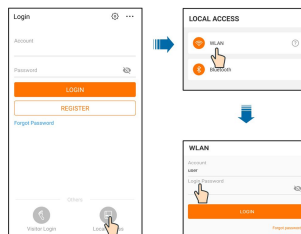

step 2 Select the relevant server for your area.

step 3 Select **Owner** or **Retailer/Installer** to enter the corresponding screen.

< BACK
Distributor/Installer
 * Contact Phone Number
 +86 > Please Enter
[Send Verification Code](#)
 * Verification Code
 Please Enter Help
 Username ?
 Please Enter
 * Password
 Please Enter
 * Confirm Password
 Please Enter
 * Country/Region >
 Please Select
 Company Name
 [Accept Privacy Policy](#)
 REGISTER

step 4 Fill in the registration information, including email, verification code, password and affirmation and country (region). The retailer/installer has the permission to fill in the company name and the code of upper level retailer/installer.



The code of upper level retailer/installer can be obtained from the upper level retailer/installer. Only when your organization belongs to the upper level retailer/installer organization, can you fill in the corresponding code.

step 5 Tick **Accept Privacy Policy** and tap **Register** to finish the registration operation.

-- End

8.4 Login

8.4.1 Requirements

The following requirements should be met:

- The AC or DC side of the inverter is powered-on.
- The WLAN function of the mobile phone is enabled.
- The mobile phone is within the coverage of the wireless network produced by the communication module.

8.4.2 Login Procedure

step 1 For the WiNet-S module, press the multi-function button 3 times to enable the WLAN hot-spot. No password is required and the valid time is 30 minutes.

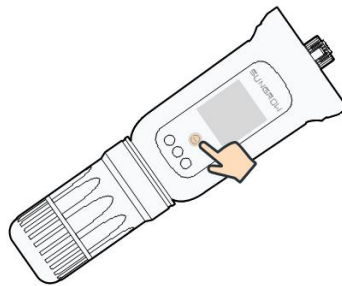

figure 8-1 Enabling the WLAN Hotspot

step 2 Connect the mobile phone to the WLAN network named as "SG-xxxxxxxxxx" (xxxxxxxxxx is the serial number indicated on the side of the communication module).

step 3 Open the App to enter the login screen. Tap **Local Access** to enter the next screen.

step 4 Tap **Confirm**, then enter the password and tap **LOGIN**. Or tap **MANUAL CONNECTION** at the bottom of the interface and select **WiNet-S**, then enter the password and tap **LOGIN**.



- If the WiFi signal, serial number or inverter related data information cannot be found, unplug and reinsert the WiNet-S or press the multi-function button of the WiNet-S three times.
- The default account is "user" and the initial password is "pw1111" which should be changed for the consideration of account security. Tap "More" at the lower right corner on home page and choose "Change Password".

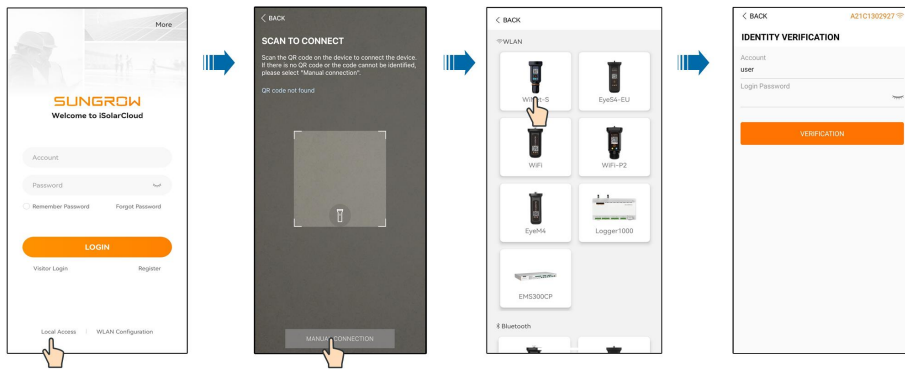

figure 8-2 WLAN Local Access

step 5 If the inverter is not initialized, navigate to the quick setting screen to initialize the protection parameters. For details, please refer to **"Initial Settings"**.

NOTICE

The "Country/Region" must be set to the country where the inverter is installed at. Otherwise, the inverter may report errors.

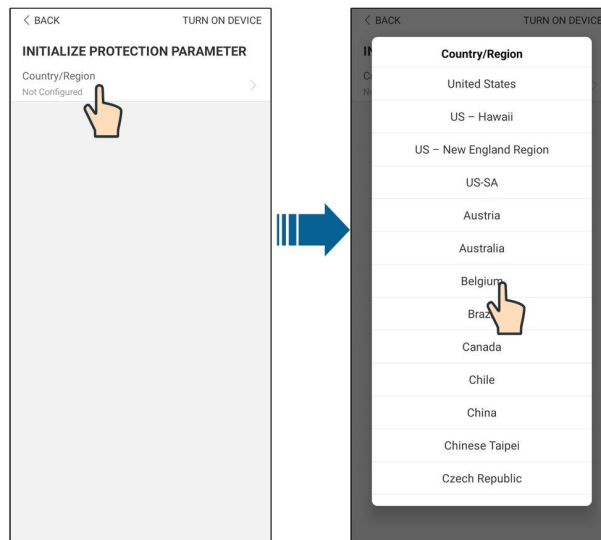

figure 8-3 WLAN Local Access

step 6 After finishing the settings, tap **TUNR ON DEVICE** at the upper right corner and the device will be initialized. The App will send start instructions and the device will start and operate.

step 7 After initialization settings, the App will return automatically to the home page.

-- End

8.5 Initial Settings

8.5.1 Feed-in Limitation

The function of the feed-in limitation is to control the amount of power injected in the grid by the plant. In some situations , this function is also called as **Export limitation** or **Zero export**. The feed-in limitation function requires the using of Smart Energy Meter. Without the Smart Energy Meter, the feed-in limitation function will be unavailable.

table 8-1 Description of feed-in limitation parameters

Parameter	Default value	Range
Feed-in Limitation	Off	On / Off
Feed-in Limitation Value	Rated power	0 ~ Rated power
Feed-in Limitation Ratio	100.0%	0 ~ 100%
Rated Power of Original Power Generation Systems	Depends on inverter power of other companies	

8.5.2 Backup Mode

The backup mode is off by default, the user can set an amount of **Reserved Battery SOC for Off-Grid**. It is the minimum battery level in the on-grid state and will be supplied to the Backup loads in case of grid blackout.

8.6 Function Overview

The App provides parameter viewing and setting functions, as shown in the following figure.

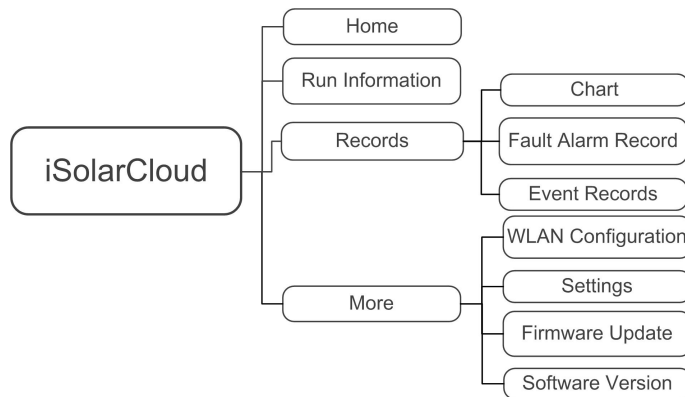

figure 8-4 App Function Tree Map

8.7 Home

Home page of the App is shown in the following figure.

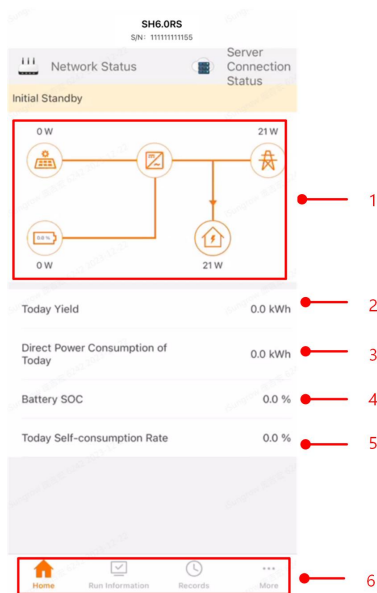



figure 8-5 Home

table 8-2 Home page description

No.	Name	Description
1	Load flow chart	Shows the PV power generation power, feed-in power, etc. The line with an arrow indicates energy flow between connected devices, and the arrow pointing indicates energy flow direction.
2	Yield Today	Shows today power generation of the inverter
3	Direct Power Consumption of Today	Shows electricity directly consumed by loads today
4	Battery SOC	Indicates remaining battery capacity
5	Today Self-consumption Rate	Indicates today self-consumption rate of the PV system
6	Navigation bar	Includes menus of Home , Run Information , Records , and More .

If the inverter runs abnormally, the fault icon  appears on the upper left corner of the screen. Users can tap the icon to view detailed fault information and corrective measures.

8.8 Run Information

Tap **Run Information** on the navigation bar to enter the corresponding screen, as shown in the following figure.

RUN INFORMATION	
PV Information ^	
String 1 Voltage	0.0 V
String 1 Current	0.00 A
String 2 Voltage	0.0 V
String 2 Current	0.00 A
Daily PV Yield	0.0 kWh
Total PV Yield	0.0 kWh
Inverter Information ^	
Running Status	Shut Down
Bus Voltage	0.0 V
Internal Air Temperature	24.9 °C
Array Insulation Resistance	0 kΩ
Country (Region) Information	Germany
Ripple Control state	No RIPP Schedule
Power Limitation Mode	Unlimited Power

figure 8-6 Run Information

The run information includes the PV information, inverter information, input, output, grid information, load information, and battery information.

8.9 Records

Tap **Records** on the navigation bar to enter the screen, as shown in the following figure.

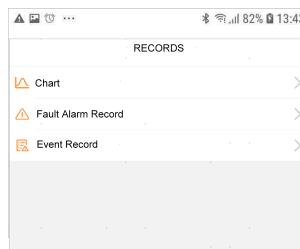

figure 8-7 Records

On **Records** screen, users can view chart and check fault alarm record.

8.9.1 Chart

Tap **Chart** to enter the screen showing daily power generation, as shown in the following figure.



figure 8-8 Power Curve

The App displays power generation records in a variety of forms, including daily power generation graph, monthly power generation histogram, annual power generation histogram, and total power generation histogram.

table 8-3 Description of power generation records

Item	Description
Daily power generation graph	Indicates today power generation, charging, feed-in power, and direct consumption power
Monthly power generation histogram	Indicates monthly power generation, charging, feed-in power, and direct consumption power
Annual power generation histogram	Indicates annual power generation, charging, feed-in power, and direct consumption power
Total power generation histogram	Indicates total power generation, charging, feed-in power, and direct consumption power

8.9.2 Fault Alarm Record

Tap **Fault Alarm Record** to enter the screen, as shown in the following figure.

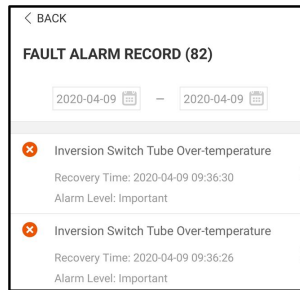

figure 8-9 Fault Alarm Record



Click "📅" to select a time segment and view corresponding records.

Select one of the records in the list and click the record, to view the detailed fault info as shown in following figure.

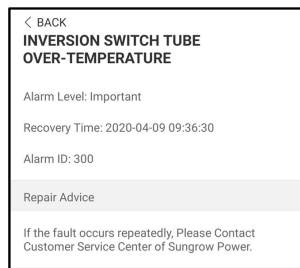

figure 8-10 Detailed fault alarm info

8.9.3 Event Record

Tap **Event Record** to enter the screen, as shown in the following figure.

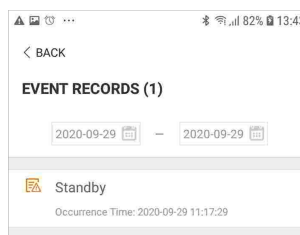

figure 8-11 Event Record



Click "📅" to select a time segment and view corresponding records.

8.10 EV Charger (Optional)



This section applies only in combination with the Sungrow 1-phase Hybrid and SBR storage system (optional) that includes the SUNGROW AC Charger AC007E-01.

Tap **Charger** in the navigation bar, and the interface is shown below.

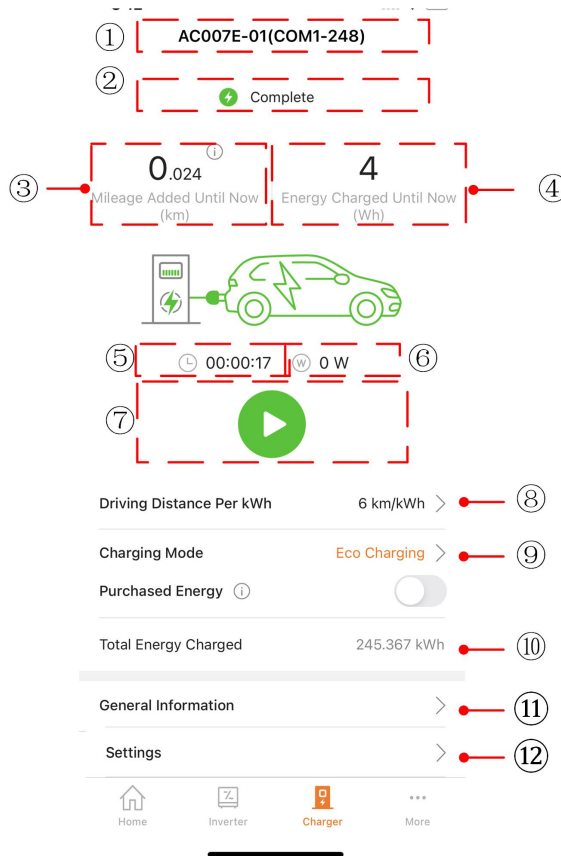

figure 8-12 EV Charger

table 8-4 EV Charger interface description

No.	Name	Description
1	Charger name	Shows the name of the connected charger
2	Charger status	Shows the current running status of an EV charger, which includes Unplugged , Standby , Charging , Charging Complete , and Disable
3	Mileage added until now	Shows the driving distance added by this charge

No.	Name	Description
4	Energy charged until now	Shows the charged energy from the start of the charger to the current moment
5	Charge duration	Shows the time from the start of the charger to the current moment
6	Charging power	Shows the charging power at the current moment
7	Start/Stop switch	Tap this button to start or stop charging. It cannot be operated if it is gray. For details, see "8.10.4 Start/Stop Switch"
8	Driving distance per kWh	For details, see "8.10.1 Driving Distance Per kWh"
9	Charging mode	The charging modes of the charger. For details, see "8.10.2 Charging Mode"
10	Total Energy Charged	Shows the cumulative charged energy from the initial charge to the current moment
11	General information	General operation information of the EV charger and the inverter, including Charger Status, Charging Power, Charge, Charging Voltage and Charging Current
12	Settings	EV charger parameter setting, including whether to enable the charger or not

8.10.1 Driving Distance Per kWh

Tap **Driving Distance Per kWh** to enter the corresponding interface.

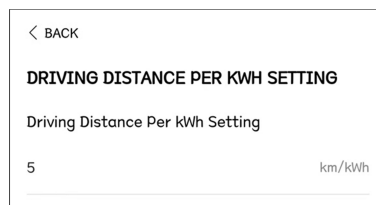

figure 8-13 Driving Distance Per kWh Setting

Driving distance per kWh is the driving distance in 1kWh of the vehicle that is being charged, and the default value is 5km/kWh. Users can set the value according to the actual vehicle condition and battery loss.

8.10.2 Charging Mode

There are four charging modes: eco charging, fast charging, scheduled charging, and customized charging.

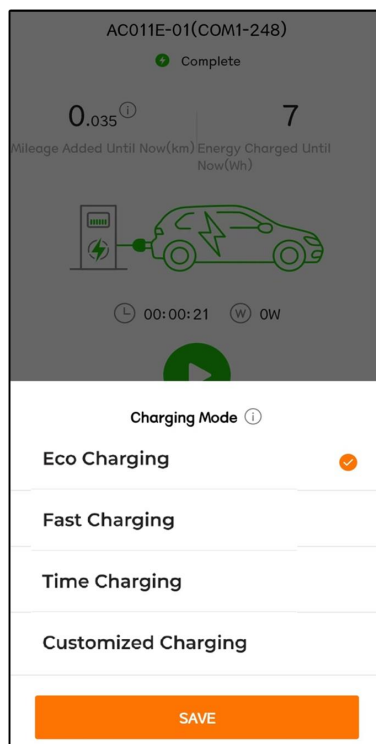



figure 8-14 Four Charging Modes



- If failed to set the mode, restart the App and try again. If the mode still cannot be set, contact the distributor first. If the problem persists, contact SUNGROW.
- The four charging modes of the EV charger can be used in the self-consumption mode of the inverter. When the inverter is in the external EMS mode, the charger can be used only in the preset charging mode.
- The four modes can be switched between each other during the charging process. After switching, the charging will stop. Please tap  to continue charging if necessary. If it is switched to "Customized" mode and the moment is not within the set charging time, it will prompt "**The current charge is completed and will continue according to the customized time**".

Eco Charging

This mode is the most economical charging mode in which the charger take priority to use PV energy to charge the vehicle while not affecting the power consumption of other household appliances.

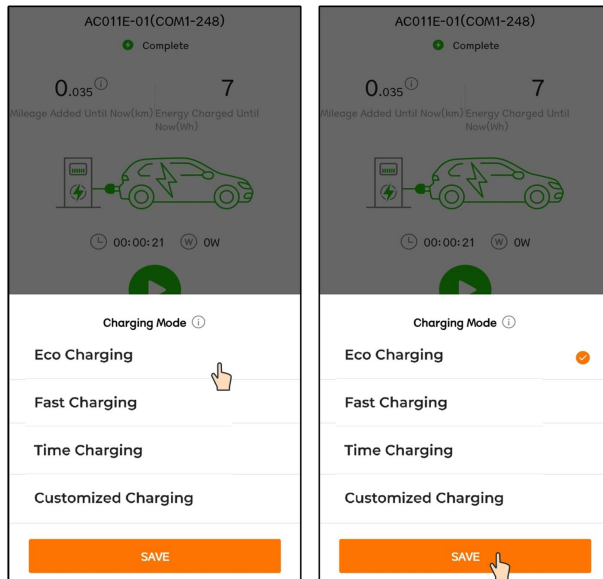
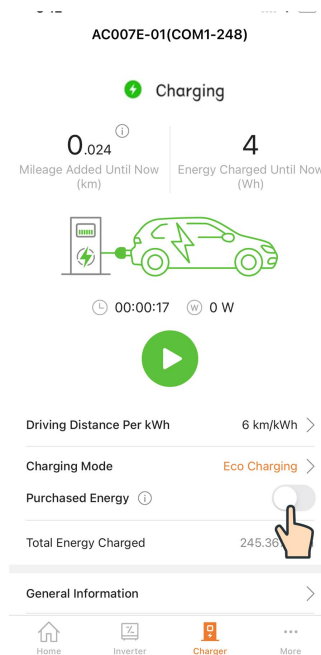

figure 8-15 Eco Charging

Select **Eco Charging** and tap **Save**.

If the PV power is lower than the minimum charging power of the charger, the battery and the power grid shall supplement the power. Tap **Purchased Energy** complete it.



Fast Charging

The charger can charge the vehicle with the maximum available power in this mode while not affecting the power consumption of other household appliances. In this case, the

charging power may come from PV modules, batteries, power grid or all. Users can choose this mode when they need to charge the vehicle urgently.

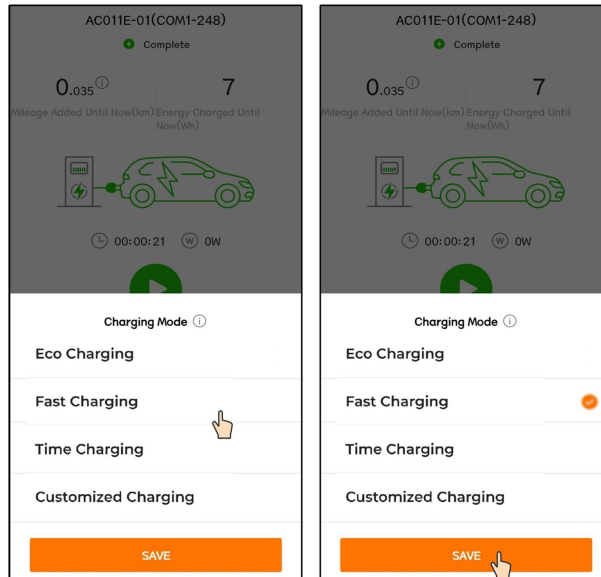

figure 8-16 Fast Charging

Select **Fast Charging** and tap **Save**.

Scheduled Charging

In this mode, the user can input the amount of kWh they want to charge, as well as the expected pickup time, the system will intelligently switch between in the green power charging mode and fast charging mode, so that the vehicle can be charged at the lowest cost before it is picked up by the user.

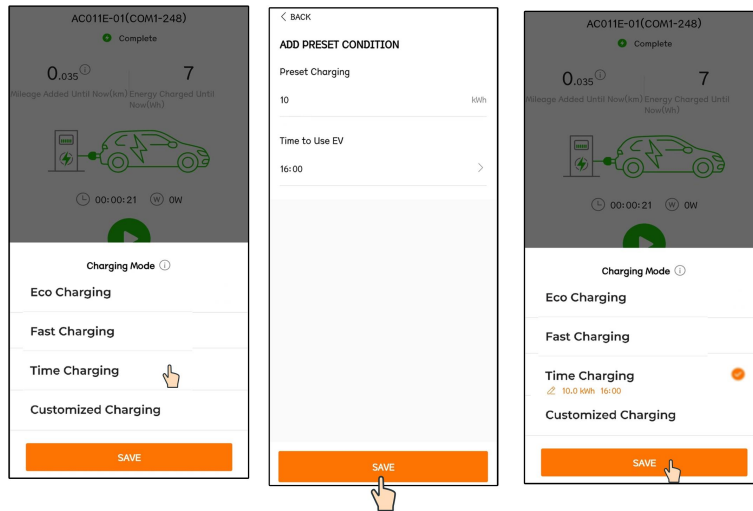

figure 8-17 Scheduled Charging

Tap **Scheduled Charging** to enter the **Add Preset Conditions** interface. Input **Target Charge** and **Time to Use**, and tap **Save**. It will jump to the time charging mode interface. Tap **Save** again to finish setting.



- If the charger has delivered the set amount of energy to the EV before the preset pickup time, the charging will end in advance.
- If the charger is not able to deliver the set amount of energy before the preset pickup time, the App will prompt **"Unable to complete the charging target before you pick up the vehicle"**. Select **"Continue"** to save the settings or select **"Cancel"** to go back to the preset condition interface.

Customized Charging

In this mode, users set the times at which the charger should start and stop charging, and the max charging current. The charging power may come from PV modules, batteries, power grid or all.

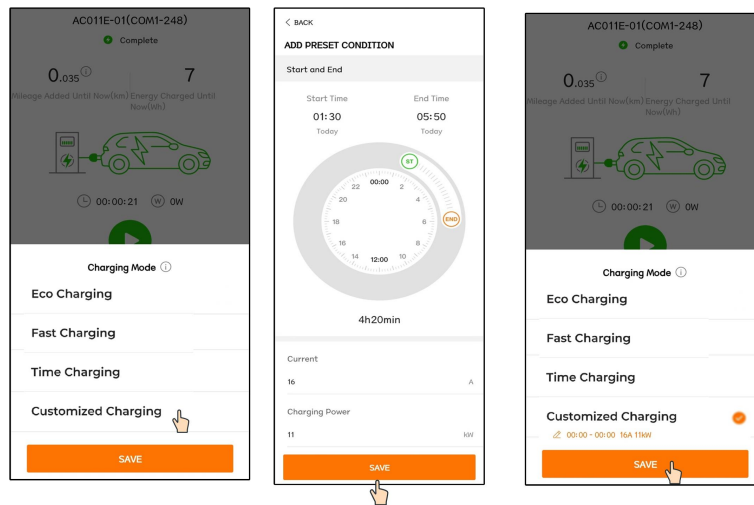

figure 8-18 Customized Charging

Select **Customized Charging** to enter the **Add Preset Conditions** interface, drag to set the charging start time and end time, input **Current** and **Charging Power**, and tap **Save**. It will jump to the customized charging interface. Tap **Save** again to finish setting.

- The minimum unit of charging time is 10 minutes.
- The current is the maximum allowable current of the charger to charge the on-board system, and the charging power is the maximum allowable charging power of the charger to charge the on-board system. The current and the corresponding charging power can be set as follows:

Current (A)	6	8	10	13	16	20	25	32
Power (kW)	1.38	1.84	2.3	2.99	3.68	4.6	5.75	7.36



- In this mode, the charger starts charging automatically at the set charging time.
- If the moment is within the set charging time and the charging cable has been inserted into the EV, click "Save" on the charging mode interface and the charger will immediately start charging the EV.

8.10.3 Parameter Setting

Tap **Settings** to enter the corresponding interface.

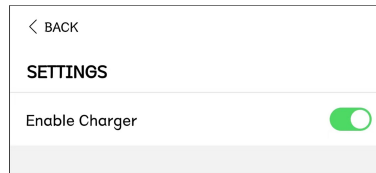



figure 8-19 Parameter Setting

Tap the switch to enable the charger.

Tap the switch again to disable the charger, in this case the charger will be in **"Disable"** status.

8.10.4 Start/Stop Switch

This switch is not visible in the installer access profile, please login with "user" to see this.

If the charging cable is inserted into the EV, and the parameters are set, the charger will be in a **"Standby"** status. Tap , the charger starts working and turns from **"Standby"** into **"Charging"**. Pull out the charging cable after the charge is completed.

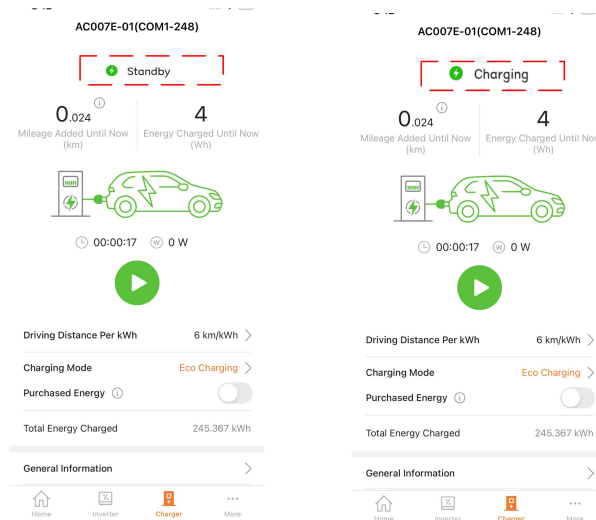

If the charger is in a **"Unplugged"** status after the charging mode is set, the charging cable may not be inserted in place. Check the connection or reconnect the cable to the EV.

To stop charging during the charging process, tap . At this time, the charging status from **"Charging"** to **"Complete"**.

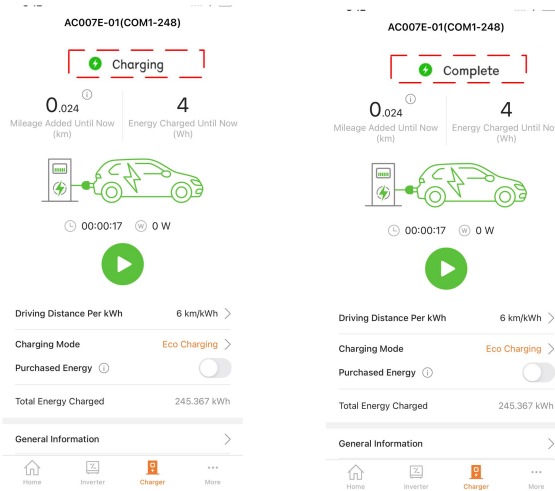

- Only the end user account has permission to turn on/off the charger.
- The charger can be turned on or off using the iSolarCloud App or the charge card (RFID). These two approaches can be used in one charging session, i.e., start the charger on the iSolarCloud App and stop it with an RFID card.

8.11 More

Tap **More** on the navigation bar to enter the screen, as shown in the following figure.

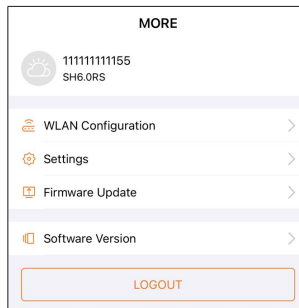
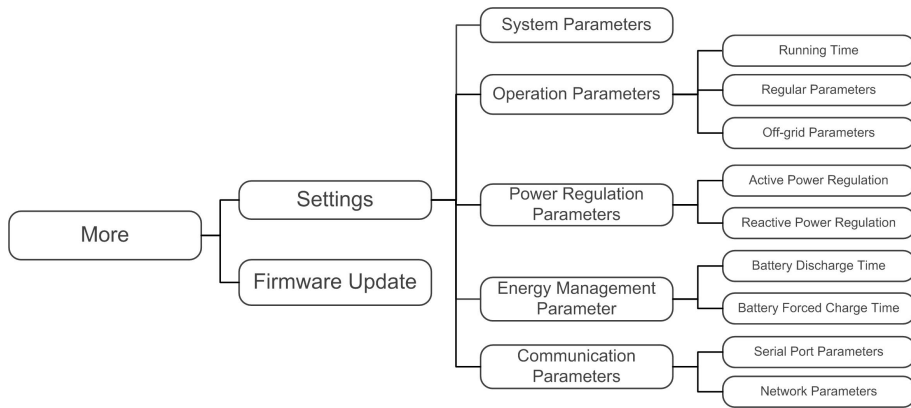

figure 8-20 More



The **More** screen supports the following operations:

- Set parameters including inverter system parameters and energy management parameter.
- Upgrade inverter firmware of the communication module.

8.11.1 System Parameters

Tap **Settings**→**System Parameters** to enter the corresponding interface, as shown in the following figure.

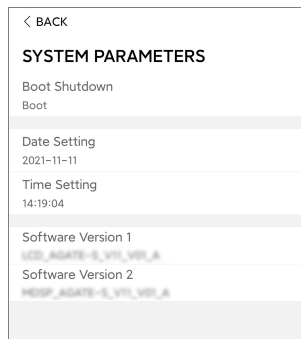

figure 8-21 System Parameters

* The image shown here is for reference only.

Boot/Shutdown

Tap **Boot/Shutdown** to send the boot/shutdown instruction to the inverter.

For Australia and New Zealand, when the DRM state is DRM0, the "Boot" option will be prohibited.

Date Setting/Time Setting

The correct system time is very important. Wrong system time will directly affect the data logging and power generation value. The clock is in 24-hour format.

Country or Region/Power Company

Here you can view the settings of country/region and power company.

Software Version

Version information of the current firmware.

8.11.2 Running Time

Tap **Settings**→**Operation Parameters**→**Running Time** to enter the corresponding screen, on which you can set **Connecting Time** and **Reconnecting Time**.

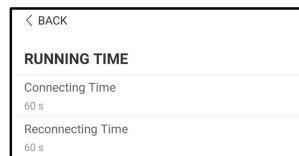

figure 8-22 Running Time

table 8-5 Description of running time parameters

Parameter	Explanation	Default	Range
Connecting Time	The time that the inverter takes to enter into the running mode from the standby mode in fault-free state	60s	10s ~ 900s
Reconnecting Time	The time that the inverter takes to recover from the fault state to normal state (the inverter is not running)	60s	0s ~ 3600s

8.11.3 Regular Parameters

Tap **Settings**→**Operation Parameters**→**Regular Parameters** to enter the screen, as shown in the following figure.

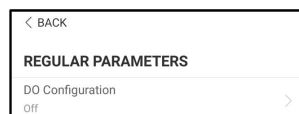

figure 8-23 Regular Parameters

After connecting the load to the DO terminals, a relay control signal will be transmitted. Users can flexibly set the control mode of DO configuration according to individual demand. NS protection is enabled, and the inverter stops in an emergency.

table 8-6 The control mode of DO configuration

Mode	Setting description
Off	-
Grounding Detection	See "8.11.11 Grounding Detection"

8.11.4 Off-grid Parameters

Tap **Settings**→**Operation Parameters**→**Off-grid Parameters** to enter the screen, as shown in the following figure.

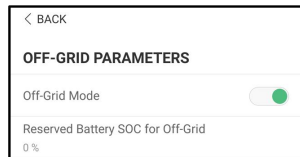

figure 8-24 Off-grid Parameters

Refer to the description in "8.5.2 Backup Mode" .

8.11.5 Active Power Regulation

Tap **Settings**→**Power Regulation Parameters**→**Active Power Regulation** to enter the screen, as shown in the following figure.

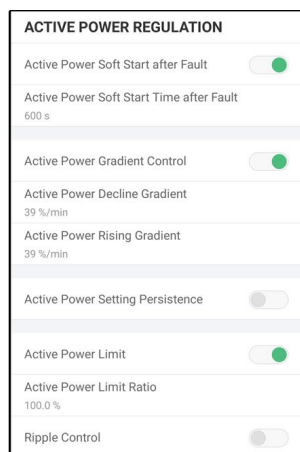

figure 8-25 Active Power Regulation

table 8-7 Description of active power regulation

Parameter	Description	Default	Range
Active Power Soft Start after Fault	Switch for activating/deactivating the function of active power soft start after a fault occurs	On	On/Off
Active Power Soft Start Time after Fault	The soft start time required for raising active power from 0 to rated value after a fault occurs	600s	1s ~ 1200s

Parameter	Description	Default	Range
Active Power Gradient Control	Set whether to enable active power gradient control	On	On/Off
Active Power Decline Gradient	Decline gradient of inverter active power per minute	39%/min	1%/min ~ 6000%/min
Active Power Rising Gradient	Rising gradient of inverter active power per minute		
Active Power Setting Persistence	Switch for activating/deactivating the function of active power setting persistence	Off	On/Off
Active Power Limit	Switch for limiting active power	On	On/Off
Active Power Limit Ratio	The ratio of active power limit to rated power in percentage	100.0%	0 ~ 100%

8.11.6 Reactive Power Regulation

Tap **Settings**→**Power Regulation Parameters**→**Reactive Power Regulation** to enter the screen, as shown in the following figure.

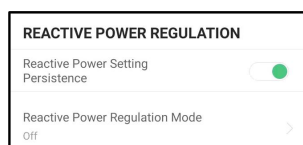

figure 8-26 Reactive Power Regulation

table 8-8 Description of reactive power regulation

Parameter	Description	Default	Range
Reactive Power Setting Persistence	Switch for activating/deactivating the function of reactive power setting persistence	On	On / Off
Reactive Power Regulation Mode	-	Off	Off / PF / Qt / Q(P) / Q(U)
Reactive Response	Reactive response function on and off	On	On / Off
Reactive Response Time	Reactive power response time	30.0s	0.1s — 600s
Reactive Power Ratio	Ratio of reactive power	0.0%	0.0% — 100%

table 8-9 Descriptions of reactive power regulation mode:

Mode	Descriptions
Off	The PF is fixed at +1.000.
PF	The reactive power can be regulated by the parameter PF (Power Factor).

Mode	Descriptions
Qt	The reactive power can be regulated by the parameter Q-Var limits (in %).
Q(P)	The PF changes with the output power of the inverter.
Q(U)	The reactive power changes with the grid voltage.

“Off” Mode

The reactive power regulation function is disabled. The PF is limited to +1.000.

“PF” Mode

The power factor is fixed and reactive power setpoint is calculated according to the current power. The PF ranges from 0.8 leading to 0.8 lagging.

Leading: The inverter supplies reactive power to the grid.

Lagging: The inverter absorbs reactive power from the grid.

“Qt” Mode

In the Qt mode, system rated reactive power is fixed, and the system injects reactive power according to the delivered reactive power ratio. The **Reactive Power Ratio** is set through the App.

The setting range of the reactive power ratio is 0~100% or 0~-100%, corresponding to the ranges of inductive and capacitive reactive power regulation respectively.

“Q(P)” Mode

The PF of the inverter output varies in response to the output power of the inverter.

table 8-10 “Q(P)” Mode Parameter Descriptions:

Parameter	Explanation	Range
Q(P) Curve	Select corresponding curve according to local regulations	A, B, C*
QP_P1	Output power at P1 on the Q(P) mode curve (in percentage)	0% ~ 100%
QP_P2	Output power at P2 on the Q(P) mode curve (in percentage)	20% ~ 100%
QP_P3	Output power at P3 on the Q(P) mode curve (in percentage)	20% ~ 100%
QP_K1	Power factor at P1 on the Q(P) mode curve	
QP_K2	Power factor at P2 on the Q(P) mode curve	Curve A/C: 0.8 ~ 1 Curve B: - 0.6 ~ 0.6
QP_K3	Power factor at P3 on the Q(P) mode curve	
QP_EnterVoltage	Voltage percentage for Q(P) function activation	100% ~ 110%
QP_ExitVoltage	Voltage percentage for Q(P) function deactivation	90% ~ 100%

Parameter	Explanation	Range
QP_ExitPower	Power percentage for Q(P) function deactivation	1% ~ 100%
QP_EnableMode	Unconditional activation/deactivation of Q (P) function	Yes / No

* Curve C is reserved and consistent with Curve A currently.

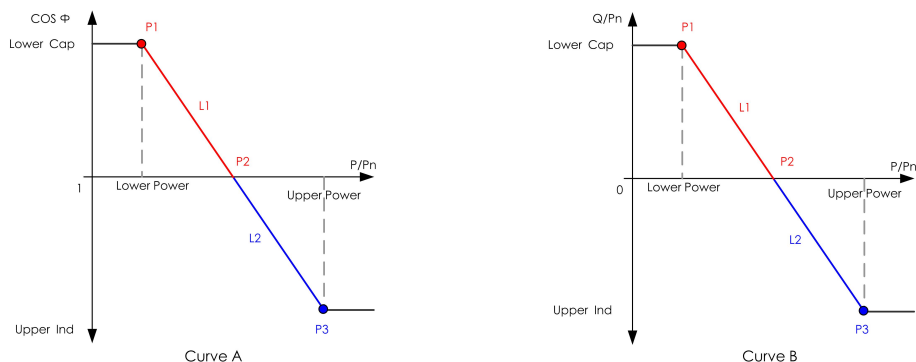

figure 8-27 Q(P) Curve

“Q(U)” Mode

The reactive power output of the inverter will vary in response to the grid voltage.

table 8-11 “Q(U)” Mode Parameter Descriptions:

Parameter	Explanation	Range
Q(U) curve	Select corresponding curve according to local regulations	A, B, C*
Hysteresis Ratio	Voltage hysteresis ratio on the Q(U) mode curve	0 ~ 5%
QU_V1	Grid voltage limit at P1 on the Q(U) mode curve	77% ~ 123%
QU_Q1	Value of Q/Sn at P1 on the Q(U) mode curve	-60% ~ 0
QU_V2	Grid voltage limit at P2 on the Q(U) mode curve	77% ~ 123%
QU_Q2	Value of Q/Sn at P2 on the Q(U) mode curve	-60% ~ 60%
QU_V3	Grid voltage limit at P3 on the Q(U) mode curve	77% ~ 123%
QU_Q3	Value of Q/Sn at P3 on the Q(U) mode curve	-60% ~ 60%
QU_V4	Grid voltage limit at P4 on the Q(U) mode curve	77% ~ 123%
QU_Q4	Value of Q/Sn at P4 on the Q(U) mode curve	0 ~ 60%
QU_EnterPower	Active power for Q(U) function activation	20% ~ 100%

Parameter	Explanation	Range
QU_ExitPower	Active power for Q(U) function deactivation	1% ~ 20%
QU_EnableMode	Unconditional activation/deactivation of Q(U) function	Yes / No / Yes, Limited by PF

* Curve C is reserved and consistent with Curve A currently.



When selecting Q(U) curve model, select Q(U) model voltage in AU, and Q(U) model ratio in other regions.

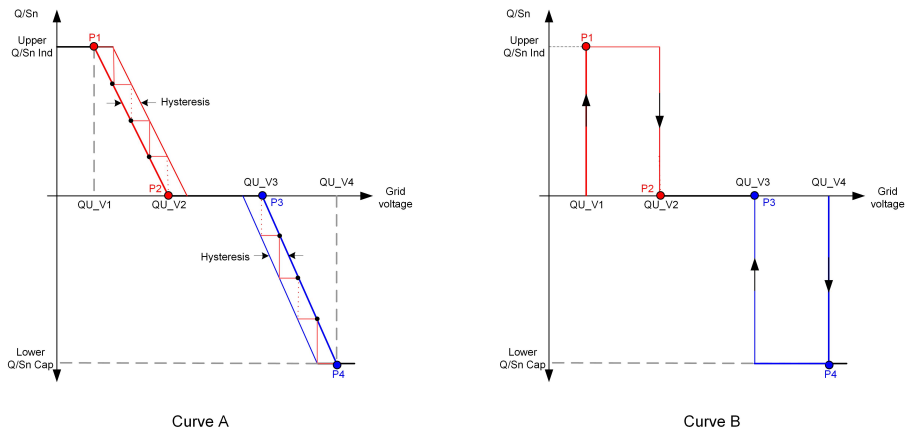

figure 8-28 Q(U) Curve

8.11.7 Battery Discharge Time

Tap **Settings**→**Energy Management Parameters**→**Battery Discharge Time** to enter the corresponding screen, as shown in the following figure.

These are the times of day at which the battery is allowed to discharge to the house loads.

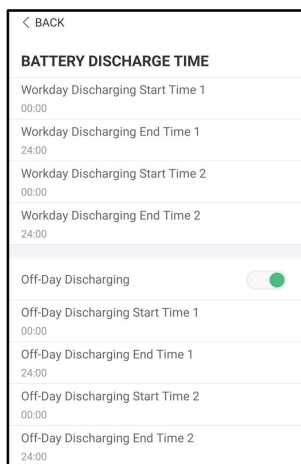

figure 8-29 Battery Discharge Time

8.11.8 Battery Forced Charge Time

Tap **Settings**→**Energy Management Parameters**→**Battery Forced Charge Time** to enter the corresponding screen.

These are the times of day at which the inverter will start charging the battery with rated AC power.

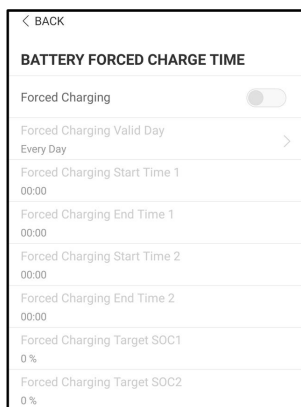

figure 8-30 Battery Forced Charge Time

When there is no PV power, the power imported from the grid charges the energy system during the time period until the target SOC is reached.

It is recommended to set the time period in off-peak tariff time. The time period 1 is in priority to the time period 2 if two periods overlap. The charging energy comes from the excess PV energy in priority and then from the grid. The inverter will take charging power from the grid in the case of PV energy shortage.

8.11.9 Communication Parameters

Tap **Settings**→**Communication Parameters** to enter the screen, as shown in the following figure.

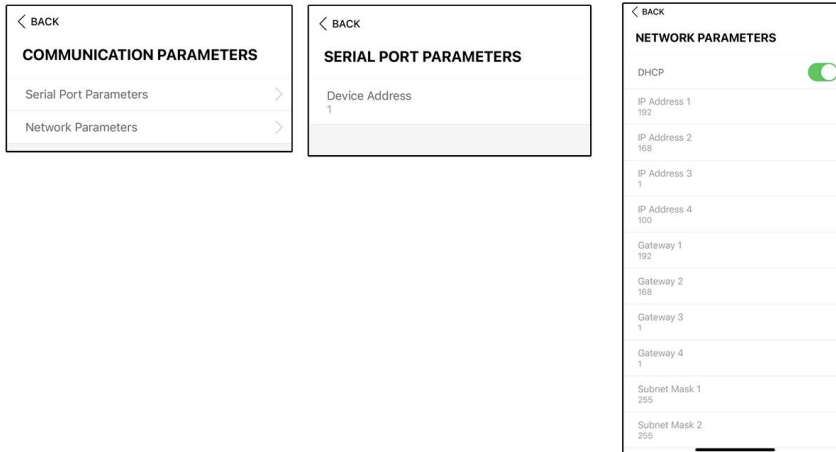



figure 8-31 Communication Parameters

- The device address ranges from 1 to 246.
- The IP address, gateway, subnet mask, preferred DNS server and alternate DNS server can be modified only when the DHCP is set to Off.
- Acquire the IP address, gateway, subnet mask, preferred DNS server and alternate DNS server from the network professional.

8.11.10 Firmware Update

To avoid download failure due to poor on-site network signal, it is recommended to download the firmware package to the mobile device in advance.

- step 1 Enable the "Mobile data" of the mobile device.
- step 2 Open the App, enter the account and password on the login screen. Tap **Login** to enter the home screen.
- step 3 Tap **More**→**Firmware Download** to enter corresponding screen on which you can view the device list.
- step 4 Select the device model before downloading the firmware. Tap the device name in the device list to enter the firmware upgrade package detail interface, and tap  behind the firmware upgrade package to download it.

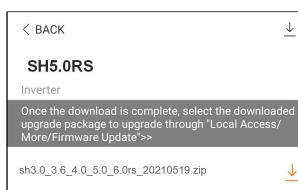

- step 5 Return to the **Firmware Download** screen, tap  in the upper right corner of the screen to view the downloaded firmware upgrade package.
- step 6 Login the App via local access mode. Refer to "8.4 Login".
- step 7 Tap **More** on the App home screen and then tap **Firmware Update**.
- step 8 Tap the upgrade package file, a prompt box will pop up asking you to upgrade the firmware with the file, tap **CONFIRM** to perform the firmware upgrade.



- step 9 Wait for the file to be uploaded. When the upgrade is finished, the interface will inform you of the upgrade completion. Tap **Complete** to end the upgrade.

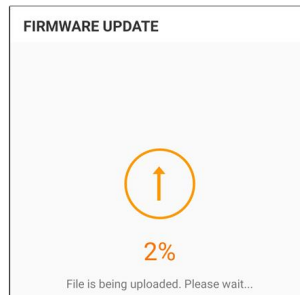

NOTICE

- **Inverter or battery firmware update must be performed when the system is running in the grid-connected state; otherwise, the backup loads may see a power failure or the update may fail.**
- **Do not take other actions, such as setting parameters, during the process of inverter firmware update, to avoid update failure.**

-- End

8.11.11 Grounding Detection



Contact your distributor to obtain the advanced account and corresponding password before setting the earth detection parameters. If the distributor is unable to provide the required information, contact SUNGROW.

Unauthorized personnel are not allowed to log in with this account. Otherwise, SUNGROW shall not be held liable for any damages caused.

Tap **More**→**Settings**→**Operation Parameters**→**Grounding Detection** to enter the corresponding screen.



figure 8-32 Grounding Detection

If the grounding detection is enabled, the DO relay will switch on automatically to signal the external alarm if the value exceeds the grounding detection alarm value. The buzzer inside the inverter will beep.

The PV insulation resistance fault (fault sub-code 039) will trigger the DO relay to signal the external alarm.

8.11.12 Frequency Shift Power Control

Tap **More**→**Settings**→**Operation Parameters**→**Other Parameters** to enter the corresponding screen.



Parameter	Default value	Range
Frequency Shift Power Control	OFF	ON / OFF
Frequency Shift Test	OFF	ON / OFF
Set Test Frequency	50.00 Hz	50.00 ~ 55.00 Hz

If PV inverters are connected on the AC side during battery-backup operation, the hybrid inverter must be able to limit their output power. This limitation becomes necessary when, for example, the hybrid inverter's battery is fully charged and the power available from the PV system exceeds the power requirement of the connected loads.

To prevent excess energy from overcharging the battery, the hybrid inverter automatically detects the problem and changes the frequency at the AC output. This frequency adjustment is analyzed by the PV inverter. As soon as the power frequency of the battery-backup grid increases beyond the value specified in **Set Test Frequency**, the PV inverter limits its output power accordingly.

Before retrofitting the existing PV system to an off-grid port, the **Frequency Shift Power Control** parameter needs to be enabled. It must be ensured that the connected PV inverters limit their power at the AC output via the hybrid inverter due to changes in frequency. The frequency-dependent active power limitation PF must be set in the PV inverter.



When the battery SOC is greater than 85%, the Hybrid inverter will standby before starting when switching off-grid, and does not support seamless switching.

8.11.13 Import Power Limit

Import power is the sum of the battery charging power and the load power of the Backup. Following local regulations, calculate the maximum system tolerable power based on the wire and circuit breaker that required by the selected model, and the value can be set as the **Import Power Limit**. The setup steps are shown below.

Tap **More**→**Settings**→**Operation Parameters**→**Other Parameters** to enter the corresponding screen.

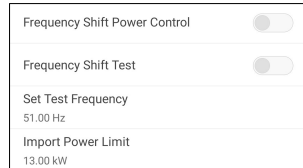

9 System Decommissioning

9.1 Decommissioning the Inverter

9.1.1 Disconnect the Inverter

⚠ CAUTION

Danger of burns!

Even if the inverter is shut down, it may still be hot and cause burns. Wear protective gloves before operating the inverter after it cools down.

For maintenance or other service work, the inverter must be switched off.

Proceed as follows to disconnect the inverter from the AC and DC power sources. Lethal voltages or damage to the inverter will follow if otherwise.

- step 1 Disconnect the external AC circuit breaker and prevent it from inadvertent reconnection.
- step 2 Rotate the DC switch to the "OFF" position for disconnecting all of the PV string inputs.
- step 3 Wait about 10 minutes until the capacitors inside the inverter completely discharge.
- step 4 Ensure that the DC cable is current-free with a current clamp.

-- End

9.1.2 Dismantling the Inverter

⚠ CAUTION

Risk of burn injuries and electric shock!

Do not touch any inner live parts until for at least 10 minutes after disconnecting the inverter from the utility grid and the PV input.



Before dismantling the inverter, disconnect both AC and DC connections.

- step 1 Refer to "[6 Electrical Connection](#)" for the inverter disconnection of all cables in reverse steps.
- step 2 Dismantle the inverter referring to "[5 Mechanical Mounting](#)" in reverse steps.
- step 3 If necessary, remove the wall-mounting bracket from the wall.
- step 4 If the inverter will be reinstalled in the future, please refer to "[4.3 Inverter Storage](#)" for a proper conservation.

-- End

9.1.3 Disposal of Inverter

Users take the responsibility for the disposal of the inverter.

WARNING

Please scrap the inverter in accordance with relevant local regulations and standards to avoid property losses or casualties.

NOTICE

Some parts of the inverter may cause environmental pollution. Please dispose of them in accordance with the disposal regulations for electronic waste applicable at the installation site.

9.2 Decommissioning the Battery

Decommission the battery in the system after the inverter is decommissioned. Proceed as follows to decommission a Li-ion battery.

- step 1 Disconnect the DC circuit breaker between the battery and the inverter.
- step 2 Disconnect the communication cable between the battery and the inverter.
- step 3 Wait for about 1 minute and then use the multimeter to measure the port voltage of the battery.
- step 4 If the battery port voltage is zero, disconnect the power cables from the battery module.

-- End



For disposal of this product, please call the phone number listed in the warranty booklet provided at the time of purchase.

10 Troubleshooting and Maintenance

10.1 Troubleshooting

Once the inverter fails, the fault information can be displayed on the App interface. If the inverter is equipped with an LCD screen, the fault information can be viewed on it.

The fault codes and troubleshooting methods of all Hybrid inverters are detailed in the table below. The device you purchase may only contain some of the fault information, and when the inverter fails, you can check the corresponding information through the fault codes from the mobile App.

Alarm ID	Alarm Name	Corrective Measures
2, 3, 14, 15	Grid Overvoltage	<p>Generally, the inverter will be reconnected to the grid after the grid returns to normal. If the fault occurs repeatedly:</p> <ol style="list-style-type: none">1. Measure the actual grid voltage, and contact the local electric power company for solutions if the grid voltage is higher than the set value.2. Check whether the protection parameters are appropriately set via the App or the LCD. Modify the overvoltage protection values with the consent of the local electric power operator.3. If the fault still exists, contact SUNGROW.
4, 5	Grid Undervoltage	<p>Generally, the inverter will be reconnected to the grid after the grid returns to normal. If the fault occurs repeatedly:</p> <ol style="list-style-type: none">1. Measure the actual grid voltage, and contact the local electric power company for solutions if the grid voltage is lower than the set value.2. Check whether the protection parameters are appropriately set via the App or the LCD.3. Check whether the AC cable is firmly in place.4. If the fault still exists, contact SUNGROW.

Alarm ID	Alarm Name	Corrective Measures
8	Grid Overfrequency	<p>Generally, the inverter will be reconnected to the grid after the grid returns to normal. If the fault occurs repeatedly:</p> <ol style="list-style-type: none"> 1. Measure the actual grid frequency, and contact the local electric power company for solutions if the grid frequency is beyond the set range. 2. Check whether the protection parameters are appropriately set via the App or the LCD. 3. If the fault still exists, contact SUNGROW.
9	Grid Underfrequency	<p>Generally, the inverter will be reconnected to the grid after the grid returns to normal. If the fault occurs repeatedly:</p> <ol style="list-style-type: none"> 1. Check whether the grid supplies power reliably. 2. Check whether the AC cable is firmly in place. 3. Check whether the AC cable is connected to the correct terminal (whether the live wire and the N wire are correctly in place). 4. Check whether the AC circuit breaker is connected. 5. If the fault still exists, contact SUNGROW.
10	Grid Power Outage	<p>Generally, the inverter will be reconnected to the grid after the grid returns to normal. If the fault occurs repeatedly:</p> <ol style="list-style-type: none"> 1. The fault can be caused by poor sunlight or damp environment, and generally the inverter will be reconnected to the grid after the environment is improved. 2. If the environment is normal, check whether the AC and DC cables are well insulated. 3. If the fault still exists, contact SUNGROW.
12	Excess Leakage Current	<p>Generally, the inverter will be reconnected to the grid after the grid returns to normal. If the fault occurs repeatedly:</p> <ol style="list-style-type: none"> 1. Measure the actual grid, and contact the local electric power company for solutions if the grid parameter exceeds the set range. 2. If the fault still exists, contact SUNGROW.
13	Grid Abnormal	<p>Generally, the inverter will be reconnected to the grid after the grid returns to normal. If the fault occurs repeatedly:</p> <ol style="list-style-type: none"> 1. Measure the actual grid, and contact the local electric power company for solutions if the grid parameter exceeds the set range. 2. If the fault still exists, contact SUNGROW.

Alarm ID	Alarm Name	Corrective Measures
17	Grid Voltage Imbalance	<p>Generally, the inverter will be reconnected to the grid after the grid returns to normal. If the fault occurs repeatedly:</p> <ol style="list-style-type: none"> 1. Measure the actual grid voltage. If grid phase voltages differ greatly, contact the electric power company for solutions. 2. If the voltage difference between phases is within the permissible range of the local power company, modify the grid voltage imbalance parameter through the App or the LCD. 3. If the fault still exists, contact SUNGROW.
28, 29, 208, 212, 448-479	PV Reverse Connection Fault	<ol style="list-style-type: none"> 1. Check whether the corresponding string is of reverse polarity. If so, disconnect the DC switch and adjust the polarity when the string current drops below 0.5 A. 2. If the fault still exists, contact SUNGROW. <p>*The code 28 to code 29 are corresponding to PV1 to PV2 respectively.</p> <p>*The code 448 to code 479 are corresponding to string 1 to string 32 respectively.</p>
532-547, 564-579	PV Reverse Connection Alarm	<ol style="list-style-type: none"> 1. Check whether the corresponding string is of reverse polarity. If so, disconnect the DC switch and adjust the polarity when the string current drops below 0.5 A. 2. If the alarm still exists, contact SUNGROW. <p>*The code 532 to code 547 are corresponding to string 1 to string 16 respectively.</p> <p>*The code 564 to code 579 are corresponding to string 17 to string 32 respectively.</p>

Alarm ID	Alarm Name	Corrective Measures
548-563, 580-595	PV Abnormal Alarm	<p>Check whether the voltage and current of the inverter is abnormal to determine the cause of the alarm.</p> <ol style="list-style-type: none"> 1. Check whether the corresponding module is sheltered. If so, remove the shelter and ensure module cleanness. 2. Check whether the battery board wiring is loose, if so, make it reliably connected. 3. Check if the DC fuse is damaged. If so, replace the fuse. 4. If the alarm still exists, contact SUNGROW. <p>*The code 548 to code 563 are corresponding to string 1 to string 16 respectively.</p> <p>*The code 580 to code 595 are corresponding to string 17 to string 32 respectively.</p>
37	Excessively High Ambient Temperature	<p>Generally, the inverter will resume operation when the internal or module temperature returns to normal.</p> <p>If the fault persists:</p> <ol style="list-style-type: none"> 1. Check whether the ambient temperature of the inverter is too high; 2. Check whether the inverter is in a well-ventilated place; 3. Check whether the inverter is exposed to direct sunlight. Shield it if so; 4. Check whether the fan is running properly. Replace the fan if not; 5. If the fault still exists, contact SUNGROW.
43	Excessively Low Ambient Temperature	<p>Stop and disconnect the inverter. Restart the inverter when the ambient temperature rises within the operation temperature range.</p>

Alarm ID	Alarm Name	Corrective Measures
39	Low System Insulation Resistance	<p>Wait for the inverter to return to normal. If the fault occurs repeatedly:</p> <ol style="list-style-type: none"> 1. Check whether the ISO resistance protection value is excessively high via the app or the LCD, and ensure that it complies with the local regulations. 2. Check the resistance to ground of the string and DC cable. Take corrective measures in case of short circuit or damaged insulation layer. 3. If the cable is normal and the fault occurs on rainy days, check it again when the weather turns fine. 4. If there are batteries, check whether battery cables are damaged and whether terminals are loose or in poor contact. If so, replace the damaged cable and secure terminals to ensure a reliable connection. 5. If the fault still exists, contact SUNGROW.
106	Grounding Cable Fault	<ol style="list-style-type: none"> 1. Check whether the AC cable is correctly connected. 2. Check whether the insulation between the ground cable and the live wire is normal. 3. If the fault still exists, contact SUNGROW.
88	Electric Arc Fault	<ol style="list-style-type: none"> 1. Disconnect the DC power supply, and check whether any DC cable is damaged, the connection terminal or fuse is loose or there is a weak contact. If so, replace the damaged cable, fasten the terminal or fuse, and replace the burnt component. 2. After performing step 1, reconnect the DC power supply, and clear the electric arc fault via the App or the LCD, after that the inverter will return to normal. 3. If the fault still exists, contact SUNGROW.
51	Off-Grid Load OverPower Fault	<ol style="list-style-type: none"> 1. Reduce the load power at the off-grid port or cut off some loads. 2. If the fault still exists, contact SUNGROW.
84	Reverse Connection Alarm of the Meter/CT	<ol style="list-style-type: none"> 1. Check if the meter is wrongly connected. 2. Check if the input and output wiring of the meter is reversed. 3. If the existing system is enabled, please check if the rated power setting of the existing inverter is correct.

Alarm ID	Alarm Name	Corrective Measures
514	Meter Communication Abnormal Alarm	<ol style="list-style-type: none"> 1. Check whether the communication cable and the terminals are abnormal. If so, correct them to ensure reliable connection. 2. Reconnect the communication cable of the meter. 3. If the alarm still exists, contact SUNGROW.
323	Grid Confrontation	<ol style="list-style-type: none"> 1. Check whether the output port is connected to actual grid. Disconnect it from the grid if so. 2. If the fault still exists, contact SUNGROW.
75	Inverter Parallel Communication Alarm	<ol style="list-style-type: none"> 1. Check whether the communication cable and the terminals are abnormal. If so, correct them to ensure reliable connection. 2. Reconnect the communication cable of the meter. 3. If the alarm still exists, contact SUNGROW.
714	BMS Communication Fault	<ol style="list-style-type: none"> 1. Check whether the communication cable and the terminals are abnormal. If so, correct them to ensure reliable connection. 2. Reconnect the communication cable of the meter. 3. If the fault still exists, contact SUNGROW.
716	Abnormal Battery Connection	<ol style="list-style-type: none"> 1. Check whether the battery is reversely connected or not connected. If so, correct the battery power cable connection. 2. If the fault still exists, contact SUNGROW.
932–935, 937, 939–943, 964, 840	Battery Alarm	<p>Generally, the battery can automatically recover. In case the alarm persist for a long time:</p> <ol style="list-style-type: none"> 1. If the alarm is caused by ambient temperature, such as over temperature alarm or low temperature alarm, take measures to change the ambient temperature, such as improving heat dissipation conditions. 2. If the fault persists, contact battery manufacturer.

Alarm ID	Alarm Name	Corrective Measures
703, 707, 708, 711, 712, 715, 717, 732– 737, 739– 747, 832– 837, 839, 841, 844, 864, 866– 868, 870, 1000, 1001	Battery Fault	<ol style="list-style-type: none"> 1. In case of abnormal battery voltage, check whether the battery power cable connection is abnormal (reverse connection, loose, etc.). If so, correct it to ensure reliable connection. 2. Check whether the battery real-time voltage is abnormal if the battery power cable is correctly connected. If so, contact the battery manufacturer. If not, contact SUNGROW. 3. In case of abnormal battery temperature, take measures to change the ambient temperature, such as improving heat dissipation conditions. 4. If the fault persists, contact battery manufacturer.
7, 11, 16, 19–25, 30– 34, 36, 38, 40–42, 44– 50, 52–58, 60–69, 85, 87, 92, 93, 100–105, 107–114, 116–124, 200–211, 248–255, 300–322, 324–328, 401–412, 600–603, 605, 608, 612, 616, 620, 622– 624, 800, 802, 804, 807, 1096– 1122	System Fault	<ol style="list-style-type: none"> 1. Wait for the inverter to return to normal. 2. Disconnect the AC and DC switches, and disconnect the battery side switches if there are batteries. Close the AC and DC switches in turn 15 minutes later and restart the system. 3. If the fault still exists, contact SUNGROW.

Alarm ID	Alarm Name	Corrective Measures
59, 70–74, 76–83, 89, 216–218, 220–233, 432–434, 500–513, 515–518, 635–638, 900, 901, 910, 911, 996	System Alarm	<ol style="list-style-type: none"> 1. The inverter can continue running. 2. Check whether the related wiring and terminal are abnormal, check whether there are any foreign materials or other environmental abnormalities, and take corresponding corrective measures when necessary. 3. If the alarm persists, please contact SUNGROW.
264-283	MPPT Reverse Connection	<ol style="list-style-type: none"> 1. Check whether the corresponding string is of reverse polarity. If so, disconnect the DC switch and adjust the polarity when the string current drops below 0.5 A. 2. If the fault still exists, contact SUNGROW. <p>*The code 264 to code 279 are corresponding to string 1 to string 20 respectively.</p>
332-363	Boost Capacitor Overvoltage Alarm	<ol style="list-style-type: none"> 1. The inverter can continue running. 2. Check whether the related wiring and terminals are abnormal, check whether there are any foreign materials or other environmental abnormalities, and take corresponding corrective measures when necessary. 3. If the alarm persists, please contact SUNGROW.
364-395	Boost Capacitor Overvoltage Fault	<ol style="list-style-type: none"> 1. Disconnect the AC and DC switches, and disconnect the battery side switches if there are batteries. Close the AC and DC switches in turn 15 minutes later and restart the system. 2. If the fault still exists, contact SUNGROW.

Alarm ID	Alarm Name	Corrective Measures
1548-1579	String Current Reflux	<ol style="list-style-type: none"> 1. Check whether the number of PV modules of the corresponding string is less than other strings. If so, disconnect the DC switch and adjust the PV module configuration when the string current drops below 0.5 A. 2. Check whether the PV module is shaded. 3. Disconnect the DC switch to check whether the open circuit voltage is normal when the string current drops below 0.5 A. If so, check the wiring and configuration of the PV module. 4. Check whether the orientation of the PV module is abnormal.
1600 - 1615, 1632 - 1655	PV Grounding Fault	<ol style="list-style-type: none"> 1. When the fault occurs, it is forbidden to directly disconnect the DC switch and unplug PV terminals when the direct current is greater than 0.5 A; 2. Wait until the direct current of the inverter falls below 0.5 A, then disconnect the DC switch and unplug the faulty strings; 3. Do not reinsert the faulty strings before the grounding fault is cleared; 4. If the fault is not caused by the foregoing reasons and still exists, contact Sungrow Customer Service.
1616	System Hardware Fault	<ol style="list-style-type: none"> 1. It is prohibited to disconnect the DC switch when the DC current is greater than 0.5 A when the fault occurs. 2. Disconnect the DC switch only when the inverter DC side current drops below 0.5 A. 3. It is prohibited to power up the inverter again. <p>Please contact Sungrow Customer Service.</p>



If the communication cable between the hybrid inverter and the battery is not connected correctly during the first installation, the battery may not work properly or the parameter information of the battery may not be displayed on the inverter. Please check the communication cable to ensure a correct connection.

Once a fault occurs to the optimizer, the fault information is displayed on the App.

Fault Code	Fault Name	Possible Cause	Corrective Method
4	Input overvoltage	The PV voltage is higher than the set protection value	1.Please check if the cables between the optimizer and PV module are reliably and properly connected. 2.Please check if the open-circuit voltage of the PV module, to which the optimizer is connected, exceeds the maximum input voltage allowed for the optimizer, or if the module's open-circuit voltage is abnormal.
512	Hardware fault	A hardware fault occurs to the optimizer	1.Please disconnect the PV module connected to the abnormal optimizer. 2.Please contact SUNGROW Customer Service to have the optimizer replaced.
1024	Update failed	The optimizer software fails to upgrade	Please check if the light conditions are normal. It is suggested to perform optimizer update again at noon when the light is good.



- If there is a string current backfeed fault, first check whether the optimizer is offline.
- Contact the dealer if the measures listed in the “Troubleshooting Method” column have been taken but the problem persists. Contact SUNGROW if the dealer fails to solve the problem.

10.2 Maintenance

10.2.1 Maintenance Notices

The DC switch can be secured with a lock in the OFF position or a certain angle beyond the OFF position.(For countries “AU” and “NZ”)

⚠ DANGER**Risk of inverter damage or personal injury due to incorrect service!**

- **Be sure to use special insulation tools when perform high-voltage operations.**
- **Before any service work, first disconnect the grid-side AC circuit breaker and check the inverter status. If the inverter indicator is off, please wait until night to disconnect the DC switch. If the inverter indicator is on, directly disconnect the DC switch.**
- **After the inverter is powered off for 10 minutes, measure the voltage and current with professional instrument. Only when there is no voltage nor current can operators who wear protective equipment operate and maintain the inverter**
- **Even if the inverter is shut down, it may still be hot and cause burns. Wear protective gloves before operating the inverter after it cools down.**
- **When maintaining the product, it is strictly prohibited to open the product if there is an odor or smoke or if the product appearance is abnormal. If there is no odor, smoke, or obvious abnormal appearance, repair or restart the inverter according to the alarm corrective measures. Avoid standing directly in front of the inverter during maintenance.**

⚠ CAUTION

To prevent misuse or accidents caused by unrelated personnel: Post prominent warning signs or demarcate safety warning areas around the inverter to prevent accidents caused by misuse.

NOTICE

Restart the inverter only after removing the fault that impairs safety performance. As the inverter contains no component parts that can be maintained, never open the enclosure, or replace any internal components.

To avoid the risk of electric shock, do not perform any other maintenance operations beyond those described in this manual. If necessary, contact your distributor first. If the problem persists, contact SUNGROW. Otherwise, the losses caused is not covered by the warranty.

NOTICE

Touching the PCB or other static sensitive components may cause damage to the device.

- **Do not touch the circuit board unnecessarily.**
- **Observe the regulations to protect against electrostatic and wear an anti-static wrist strap.**

10.2.2 Quick Shutdown

The PV system can perform a quick shutdown, reducing the output voltage of strings to below 30 V within 20 s.

Triggering methods of quick shutdown:

- Method 1: Turn off the AC circuit breaker between the inverter and the grid.
- Method 2: Connect RSD-1 and RSD-2 in COM2 port to trigger quick shutdown. Disconnect RSD-1 and RSD-2 to exit the quick shutdown mode.

NOTICE

- **The quick shutdown is not supported if optimizers are configured for some PV modules.**
- **Please check regularly whether the quick shutdown function is normal.**

10.2.3 Routine Maintenance

Item	Method	Period
Device clean	Check the temperature and dust of the inverter. Clean the inverter enclosure if necessary.	Six months to a year (depending on the dust contents in air)
Electrical connection	Check whether all cable are firmly connected in place. Check whether there is damage to the cables, especially the surface in contact with metal.	6 months after commissioning and then once or twice a year
General status of the system	<ul style="list-style-type: none"> • Visual check for any damage or deformation of the inverter. • Check any abnormal noise during the operation. • Check each operation parameter. • Be sure that nothing covers the heat sink of the inverter. 	Every 6 months

11 Appendix

11.1 Technical Data

Parameter	SH3.0RS	SH3.6RS
Input (DC)		
Recommended max. PV input power*	4500 Wp	5400 Wp
Max. PV input voltage	600 V	
Min. operating PV voltage / Start-up input voltage	40 V / 50 V	
Rated PV input voltage	360 V	
MPP voltage range	40 V - 560 V	
MPP voltage range for rated power	140V - 480V	170V - 480V
No. of independent MPP inputs	2	
Default No. of PV strings per MPPT	1	
Max. PV input current	32 A (16 A / 16 A)	
Max. DC short-circuit current	40 A (20 A / 20 A)	
Input / Output (AC)		
Max. AC input power from grid	10000 VA	10700 VA
Rated AC output power	3000 W	3680 W
Max. AC output power	3000 VA	3680 VA
Rated AC output apparent power	3000 VA	3680 VA
Rated AC output current (at 230V)	13.1 A	16.0 A
Max. AC output current	13.7 A	16.0 A
Rated AC voltage	220 V / 230 V / 240 V	
AC voltage range	154 V - 276 V	
Rated grid frequency / Grid frequency range	50Hz / 45 - 55Hz 60Hz / 55 - 65Hz	
Harmonic (THD)	< 3 % (of rated power)	
Power factor at rated power / Adjustable power factor	> 0.99 at default value at rated power (adj. 0.8 overexcited / leading to 0.8 underexcited / lagging)	

Parameter	SH3.0RS	SH3.6RS
Feed-in phases / connection phases		1 / 1
Efficiency		
Max. efficiency / European efficiency	97.4% / 97.0%	97.5% / 97.1%
Protection		
Grid monitoring		Yes
DC reverse polarity protection		Yes
AC short circuit protection		Yes
Leakage current protection		Yes
Surge Protection		DC Type II / AC Type II
DC switch (solar)		Yes
DC fuse (battery)		Yes
PID recovery function		Yes
Battery input reverse polarity protection		Yes
Protective Class		I
Overvoltage Category		DC II/AC III
Active Anti-Islanding Method		Frequency Shift
Battery Data		
Battery type		Li-ion battery
Battery voltage		80 V - 460 V
Max. charge / discharge current		30 A / 30 A
Max. charge / discharge power		6600 W
General Data		
Dimensions (W x H x D)		490 mm x 340 mm x 170 mm
Weight		18.5 kg
Mounting method		Wall-mounting bracket
Topology (Solar / Battery)		Transformerless / Transformerless
Degree of protection		IP65
Operating ambient temperature range		-25°C to 60°C
Allowable relative humidity range		0 - 100 %
Cooling method		Natural convection
Max. operating altitude		4000 m
Display		LED digital display, LED indicator
Communication		RS485 / Ethernet / WLAN / CAN
DI / DO		DI * 4 / DO * 1 / DRM

Parameter	SH3.0RS	SH3.6RS
DC connection type	MC4 (PV) / Sunclix (Battery) / Evo2 Compatible (Battery)	
AC connection type	Plug and play	
Country of manufacture	China	
Backup Data (on grid mode)		
Rated output power for backup load	6000 W	
Rated output current for backup load	27.3 A	
Backup Data (off-grid mode)		
Rated voltage	220 V / 230 V / 240 V (±2 %)	
Frequency range	50 Hz / 60 Hz (±0.2 %)	
Total output THDv for linear load	< 2 %	
Switch time to emergency mode	< 10 ms	
Rated output power	3000 W / 3000 VA	3680 W / 3680 VA
Peak output power	8400 VA , 10s	

*Max. input PV power is 13,000 Wp.

Parameter	SH4.0RS	SH5.0RS	SH6.0RS
Input (DC)			
Recommended max. PV input power*	6000 Wp	7500 Wp	9000 Wp
Max. PV input voltage	600 V		
Min. operating PV voltage / Start-up input voltage	40 V / 50 V		
Rated PV input voltage	360 V		
MPP voltage range	40 V - 560 V		
MPP voltage range for rated power	190V - 480V	235V - 480V	285V - 480V
No. of independent MPP inputs	2		
Default No. of PV strings per MPPT	1		
Max. PV input current	32 A (16 A / 16 A)		
Max. DC short-circuit current	40 A (20 A / 20 A)		
Input / Output (AC)			
Max. AC input power from grid	11000 VA	12000 VA	13000 VA

Parameter	SH4.0RS	SH5.0RS	SH6.0RS
Rated AC output power	4000 W	4999 W for "AU", 5000 W for others	6000 W
Max. AC output power	4000 VA	4999 VA for "AU", 5000 VA for others	6000 VA
Rated AC output apparent power	4000 VA	4999 VA for "AU", 5000 VA for others	6000 VA
Rated AC output current (at 230V)	17.4 A	21.7 A for "AU", 21.8 A for others	26.1 A
Max. AC output current	18.2 A	21.7 A for "AU", 22.8 A for others	27.3 A
Rated AC voltage	220 V / 230 V / 240 V		
AC voltage range	154 V - 276 V		
Rated grid frequency / Grid frequency range	50Hz / 45 - 55Hz 60Hz / 55 - 65Hz		
Harmonic (THD)	< 3 % (of rated power)		
Power factor at rated power / Adjustable power factor	> 0.99 at default value at rated power (adj. 0.8 overexcited / leading-0.8 underexcited / lagging)		
Feed-in phases / connection phases	1 / 1		
Efficiency			
Max. efficiency / European efficiency	97.6% / 97.2%	97.7% / 97.3%	97.7% / 97.3%
Protection			
Grid monitoring	Yes		
DC reverse polarity protection	Yes		
AC short circuit protection	Yes		
Leakage current protection	Yes		
Surge protection	DC Type II / AC Type II		
DC switch (solar)	Yes		
DC fuse (battery)	Yes		
PID recovery	Yes		
Battery input reverse polarity protection	Yes		

Parameter	SH4.0RS	SH5.0RS	SH6.0RS
Protective Class		I	
Overvoltage Category		DC II/AC III	
Active Anti-Islanding Method		Frequency Shift	
Battery Data			
Battery type		Li-ion battery	
Battery voltage		80 V - 460 V	
Max. charge / discharge current		30 A / 30 A	
Max. charge / discharge power		6600 W	
General Data			
Dimensions (W x H x D)		490 mm x 340 mm x 170 mm	
Weight		18.5 kg	
Mounting method		Wall-mounting bracket	
Topology (solar / battery)		Transformerless / Transformerless	
Degree of protection		IP65	
Operating ambient temperature range		-25°C to 60°C	
Allowable relative humidity range		0 - 100 %	
Cooling method		Natural convection	
Max. operating altitude		4000 m	
Display		LED digital display, LED indicator	
Communication		RS485 / Ethernet / WLAN / CAN	
DI / DO		DI * 4 / DO * 1 / DRM	
DC connection type	MC4 (PV) / Sunclix (Battery) / Evo2 Compatible (Battery)		
AC connection type		Plug and play	
Country of manufacture		China	
Backup Data (on grid mode)			
Rated output power for backup load		6000 W	
Rated output current for backup load		27.3 A	
Backup Data (off-grid mode)			
Rated voltage		220 V / 230 V / 240 V (±2 %)	
Frequency range		50 Hz / 60 Hz (±0.2 %)	
Total output THDv for linear load		< 2 %	

Parameter	SH4.0RS	SH5.0RS	SH6.0RS
Switch time to emergency mode		< 10ms	
Rated output power	4000 W / 4000 VA	5000 W / 5000 VA	6000 W / 6000 VA
Peak output power		8400VA , 10s	

*Max. input PV power is 13,000 Wp.

11.2 Quality Assurance

When product faults occur during the warranty period, SUNGROW will provide free service or replace the product with a new one.

Evidence

During the warranty period, the customer shall provide the product purchase invoice and date. In addition, the trademark on the product shall be undamaged and legible. Otherwise, SUNGROW has the right to refuse to honor the quality guarantee.

Conditions

- After replacement, unqualified products shall be processed by SUNGROW.
- The customer shall give SUNGROW a reasonable period to repair the faulty device.

Exclusion of Liability

In the following circumstances, SUNGROW has the right to refuse to honor the quality guarantee:

- The free warranty period for the whole machine/components has expired.
- The device is damaged during transportation by the user.
- The device is incorrectly installed, refitted, or used.
- The device operates in harsh conditions beyond those described in this manual.
- The fault or damage is caused by installation, repairs, modification, or disassembly performed by a service provider or personnel not from SUNGROW.
- The fault or damage is caused by the use of non-standard or non-SUNGROW components or software.
- The installation and use range are beyond stipulations of relevant international standards.
- The damage is caused by unexpected natural factors.

For faulty products in any of above cases, if the customer requests maintenance, paid maintenance service may be provided based on the judgment of SUNGROW.

11.3 Contact Information

In case of questions about this product, please contact us.

We need the following information to provide you the best assistance:

- Model of the device
- Serial number of the device
- Fault code/name
- Brief description of the problem

For detailed contact information, please visit: <https://en.sungrowpower.com/contactUS>