



# SP PRO SCERT Fronius Primo or Symo Managed AC Coupling

## Introduction

The SP PRO Managed AC Coupling, provides a method of linking Selectronic Certified (SCERT) Fronius Primo or Symo grid tie inverters to the SP PRO via the AC Load supply. Regardless of whether the grid or a generator is connected, the SP PRO can manage and control Fronius SCERT inverters.

Each SP PRO Manager can control a maximum of five Fronius SCERT inverters by commanding each one to output the required amount of power to simultaneously supply the load, export to the grid and charge the battery bank as required at any particular point in time. This is done via a communications link between the SP PRO and the Fronius SCERT.

This document applies to SCERT Fronius Primo or Symo inverters which have been pre-configured and programmed by Selectronic, and details the steps needed to install a managed AC Coupled system. SCERT inverters can be identified by a sticker on the front of the product.

Each inverter must be installed as per their individual installation instructions with the additional allowance for communications cables linking all of the inverters together.

**Note:** This document needs to be read in conjunction with the SP PRO Instruction Manual and the Fronius Primo or Symo Instruction Manual.

## No SP PRO Installed? Important information

If the Fronius SCERT inverter is not yet connected to an SP PRO, refer to **Fronius SCERT Backup Ready Connection** instructions – Appendix VI.

# SP PRO SCERT Fronius Primo or Symo Managed AC Coupling Installation Notes



## Compatibility table

SP PRO System	Primo SCERT	Symo SCERT
SP PRO series I single phase	✓	✗
SP PRO series II single phase	✓	✗
SP PRO series II three phase (legacy)	✓	✗
SP PRO 2i single phase	✓	✗
SP PRO series II with Advanced Comms cards, three phase	✓	✓
SP PRO 2i Powerchain three phase.	✓	✓

- Only make adjustments to the Primo or Symo configuration as indicated in this document.
- The SP PRO and Fronius SCERT Managed AC coupling cannot be used with a Fronius Smart Meter. See Appendix III: Disable Fronius Smart Meter (page 36).

## MINIMUM battery capacity for Solar Hybrid & Off Grid Systems

Each application will have a minimum battery capacity and a maximum allowable PV, please refer to the battery manufacturers data sheet as well as the guidance given in the SP LINK Site Configuration Wizard.

### Note:

- For a Solar Hybrid (grid connected) system, the minimum battery capacity that must be connected to the SP PRO varies depending on SP PRO model. When the system is islanded (e.g. during a grid outage) the SP PRO will limit the output of the AC coupled solar based on the actual installed battery size.*
- For an Off-Grid system, the minimum battery capacity connected to the SP PRO varies depending on SP PRO model, an overriding minimum battery capacity and the combined maximum Fronius SCERT AC Output.*

# SP PRO SCERT Fronius Primo or Symo Managed AC Coupling Installation Notes



## Installation check list

The following table summarises the steps taken to set up a Fronius SCERT in a Managed AC Coupled system. Once the system has been installed, use the table to check that each step has been completed.

Refer to the pages following the tables for detailed information on each of the installation steps.

Installation step		Pages	SP PRO Series I	SP PRO Series II	SP PRO Series 2i
1	Install SP PROs as per manual		✓	✓	✓
2	Install and configure batteries		✓	✓	✓
3	Installing Fronius SCERT as per Fronius manual		✓	✓	✓
4	Fronius Primo or Symo must be SCERT - Selectronic Certified	7	✓	✓	✓
5	SP PRO Firmware Requirement – V12.18 or higher	7	✓	✓	✓
6a	Fronius Primo AC Wiring	8	✓	✓	✓
6b	Fronius Symo AC Wiring	10	x	✓ (inc ACC)	✓
7	Communications Link (RS485)	11	x	x	✓
8	RS485 Communication connection between SP PRO and Fronius SCERT Master unit	12	x	x	✓
9	Communications link for multiple installed Fronius SCERTs	14	✓	✓	✓
10	Configure SP PRO	16	✓	✓	✓
11	Configure the Fronius SCERT for the first time	16	✓	✓	✓
12	Test system function	20	✓	✓	✓
OPTIONS – as required					
	Appendix I – Connecting to Datamanger card	25	✓	✓	✓
	Appendix II – Datamanger Configuration	25	-	-	-
	Appendix III – Disable Fronius Smart Meter	36	✓	✓	✓
	Communications Link (RS485) Appendix iv – Connection using "AC Coupled Interface "Sergio" card	40	✓	✓	
	Appendix V – Fronius Failsafe Configuration	45	✓	✓	✓
	Appendix VI Installing Fronius SCERT without an SP PRO	46	-	-	-

# SP PRO SCERT Fronius Primo or Symo Managed AC Coupling Installation Notes



## Overview – Single Phase Series 2i

The diagram below shows a managed AC coupled system with five Fronius Primos.

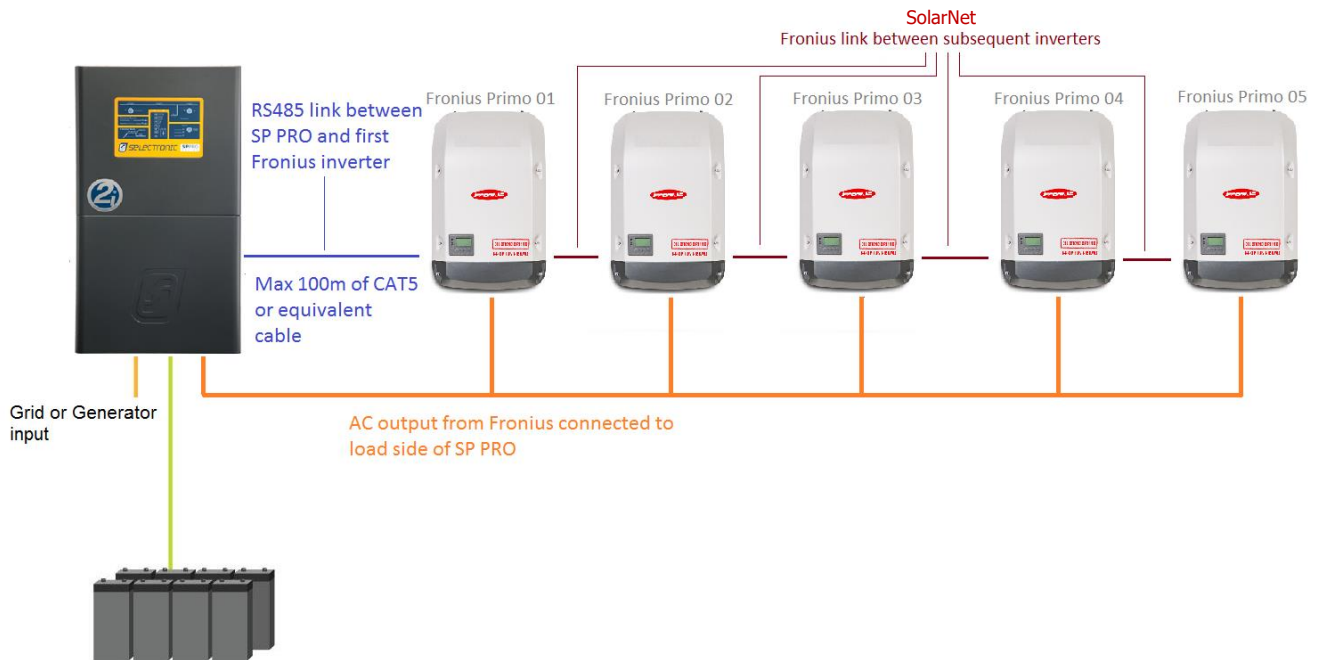

## Overview – Three phase Series 2i

The diagram below shows a managed AC coupled system with five Fronius Symo.

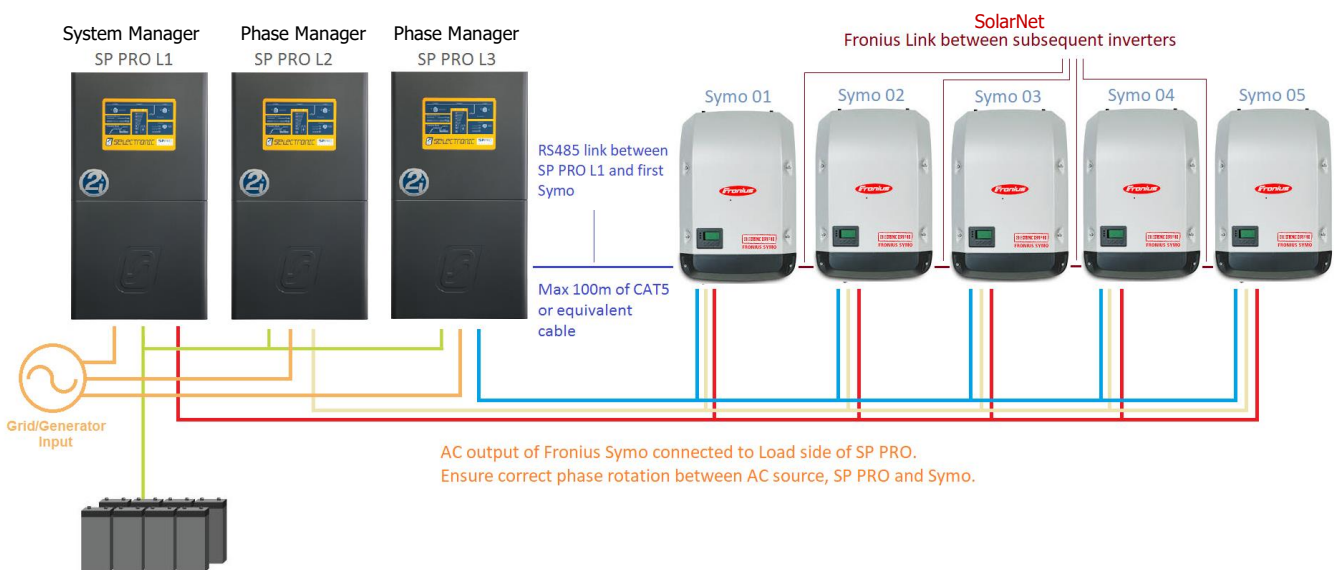

# SP PRO SCERT Fronius Primo or Symo Managed AC Coupling Installation Notes



## System Requirements

To successfully install a SP PRO Series 2i Fronius SCERT managed system, there are particular system requirements that need to be met.

- SP LINK Site Configuration Wizard must be used to verify:
  1. Combined maximum Fronius AC output does not exceed two times the SP PRO continuous power
  2. Battery bank size to suit SP PRO model and Fronius Output power
- The SP PRO must have firmware version 12.18 or higher.
- The Fronius inverters must be Selectronic Certified (SCERT).
- Fronius Primo and Symo units cannot be controlled by the same System or Phase manager.
- Maximum of five Fronius Primo SCERTs per SP PRO Manager in a single phase system. Worker units are not able to control SCERT inverters.
- Maximum of fifteen (five SCERTs per SP PRO Manager) Fronius SCERTs in a three phase system. Worker units are not able to control SCERT inverters.
- For legacy Advanced Multi Phase (pre Powerchain) systems –
  - Maximum of five Fronius SCERTs only.
  - SCERTs can only be controlled by SP PRO on L1.
  - There CANNOT be a mix of Fronius Primo and Fronius Symo within the same power system.

To configure the SP PRO - Fronius system, the Site Configuration Wizard in SP LINK's Easy Start Guide must be used.

# SP PRO SCERT Fronius Primo or Symo Managed AC Coupling Installation Notes



## Overview – Series I

### SUITABLE FOR SINGLE PHASE SYSTEMS ONLY

The diagram below shows a managed AC coupled system with five Fronius Primo inverters.

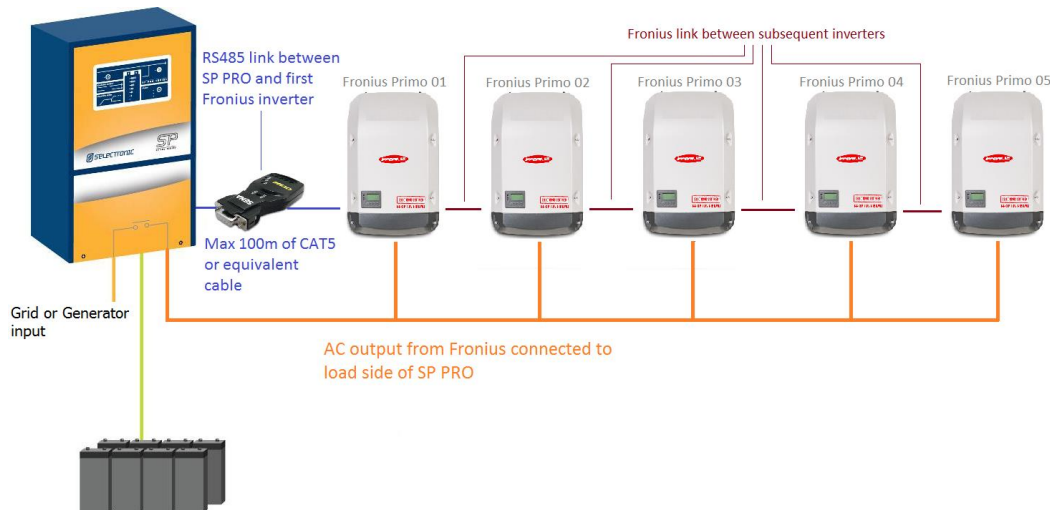

## System Requirements

To successfully install a SP PRO Series I Fronius SCERT managed system, there are particular system requirements that need to be met.

- SP LINK Site Configuration Wizard must be used to verify:
  - Combined maximum Fronius AC output does not exceed two times the SP PRO continuous power
  - Battery bank size to suit SP PRO model and Fronius Output power
- To install an AC coupled system using a Series I SP PRO an additional AC coupling adaptor (stock code 005077) is required.
- The SP PRO must have firmware version 12.18 or higher.
- The Fronius Primo must be Selectronic Certified (SCERT).
- Maximum of five Fronius Primos per SP PRO

To configure the SP PRO Fronius system, the Site Configuration Wizard in SP LINK's Easy Start Guide must be used.

# SP PRO SCERT Fronius Primo or Symo Managed AC Coupling Installation Notes



## SP PRO Firmware Requirements

1. All SP PRO Revisions are supported for the Fronius Primo SCERT.
2. Only SP PRO 2i (Revision 22) and above or Revision 20 and above when fitted with Advanced Comms Cards, are supported for Fronius Symo SCERT.
3. SP PRO Software Version 12.18 or higher is required.
4. Older revisions of firmware must be updated.
5. Do not change any configuration settings until the firmware is updated.

To check firmware revision run SP LINK, connect to the SP PRO and go to Data View – Technical Data – “SP PRO Revision” and “Software Version”.

Inverter	
SP PRO Model	Control PCA Serial
SPMC482-AU	121331
SP PRO Ratings	Control PCA Revision
48V DC, 7.5kW, 240V AC	22
SP PRO Serial Number	Control PCA Mod Status
125055	
SP PRO Revision	Power PCA 1 Serial
23	115531
SP PRO Mod Status	Power PCA 1 Revision
	3
Software Version	Power PCA 1 Mod Status
12.18.M4	
String Inverters Supported	Power PCA 2 Serial
Fronius	115755
Grid Connect SW Version	Power PCA 2 Revision
2.00	3
SP PRO Total Run Time	Power PCA 2 Mod Status
30233.0 h	

*Data View – Technical Data screen*

**Note:** Selectronic web site – <http://www.selectronic.com.au> for latest SP LINK software with the SP PRO firmware included.

## FRONIUS PRIMO OR SYMO MUST BE SELECTRONIC CERTIFIED

The Fronius inverter must be Selectronic Certified. Other Fronius inverters will not operate correctly.

**SELECTRONIC CERTIFIED**

**Note:** Do not update Fronius SCERT firmware or Datamanager firmware

# SP PRO SCERT Fronius Primo or Symo Managed AC Coupling Installation Notes



## Installation

The SP PRO and Fronius SCERTs must be installed as per their respective installation instructions. Particular instructions directly related to Managed AC Coupling are listed below.

It is good practice to number each Fronius SCERT from 1 up to 5 so that each inverter can be easily referenced within SP LINK.

In a multiphase system, label each Fronius Primo SCERT connected to L1, from L1-1 to L1-5. Do the same for each of the Fronius Primos connected to L2, from L2-1 to L2-5, and so on.

This number 1 to 5 is used for the communications link addressing. See Configuration section.

## Fronius AC wiring Primo

For correct and safe operation, the Fronius AC output wiring must be connected to the AC Load terminals of the SP PRO in accordance with local wiring rules.

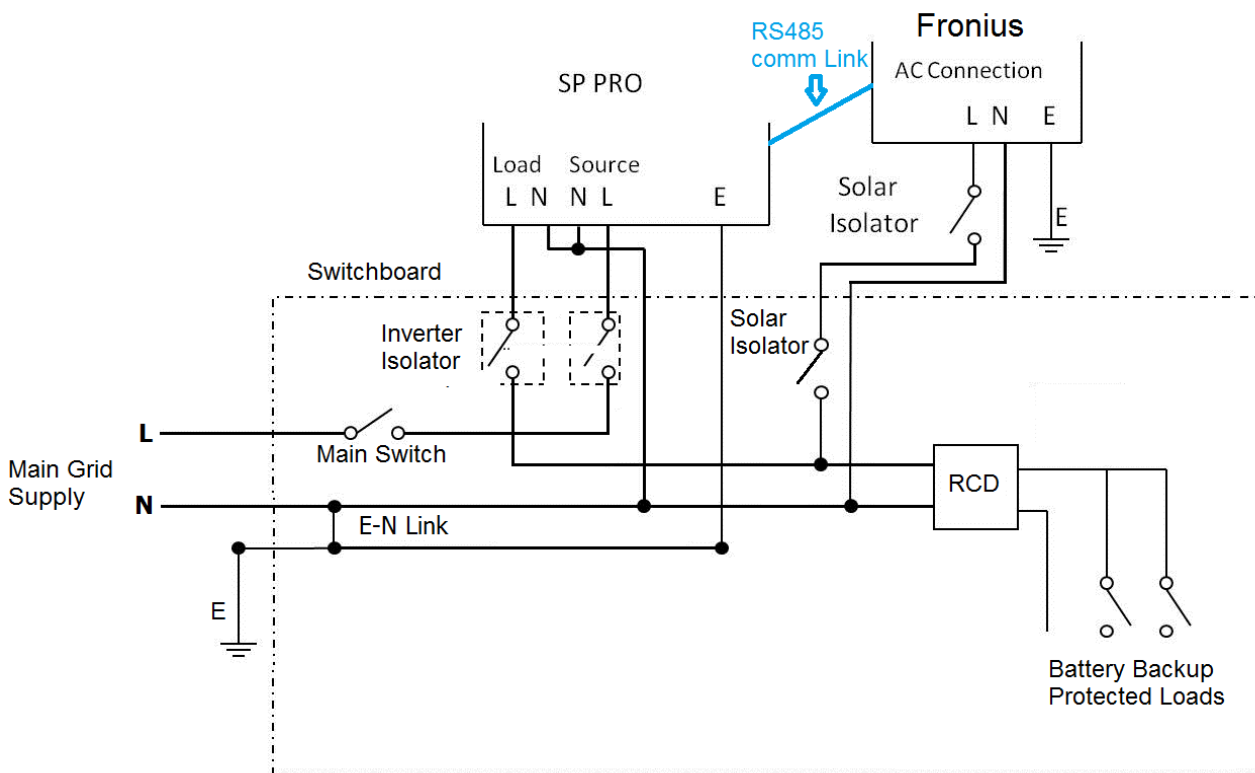

*Fronius AC Wiring guide for Grid connected installation*



# SP PRO SCERT Fronius Primo or Symo Managed AC Coupling Installation Notes

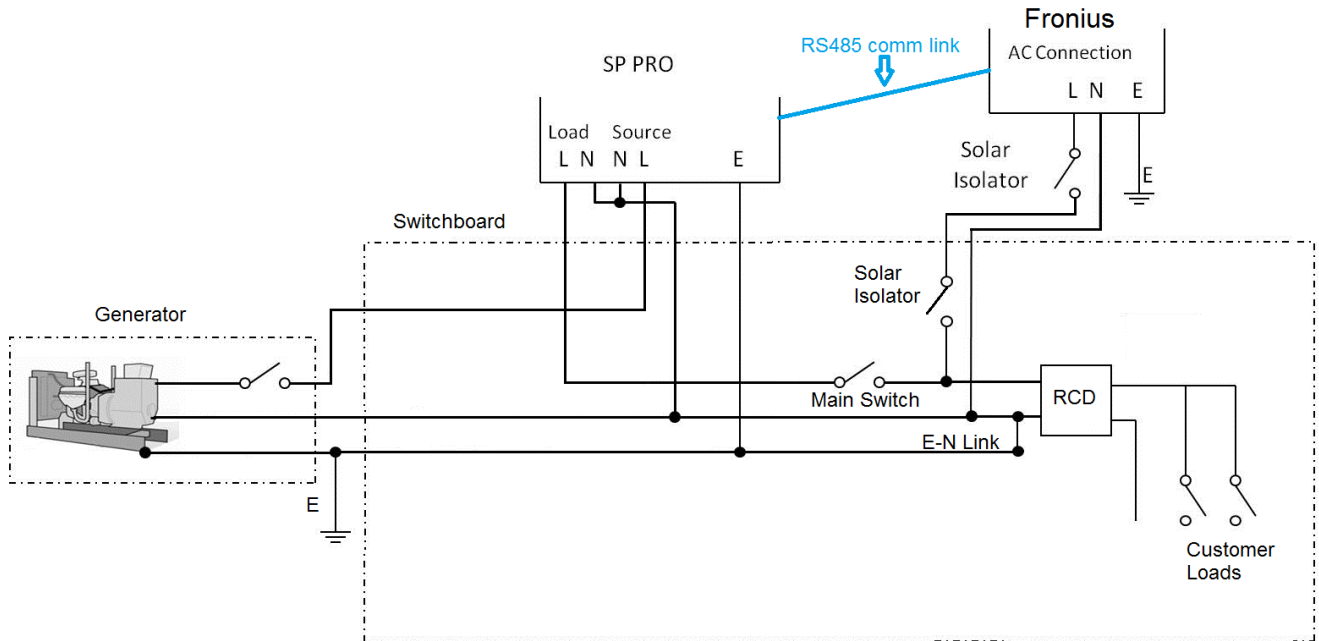

*Fronius AC Wiring guide for Off Grid installation*

**Note:** The system will not function correctly if the Fronius Primos are installed on the AC Source side of the SP PRO.

# SP PRO SCERT Fronius Primo or Symo Managed AC Coupling Installation Notes



## Fronius AC wiring Symo

For correct and safe operation, the Fronius AC output wiring must be connected to the AC Load terminals of the SP PRO in accordance with local wiring rules.

It is important that the phase rotation of the Fronius Symo inverters match that of the SP PRO three phase system. L1 to L1, L2 to L2 and L3 to L3

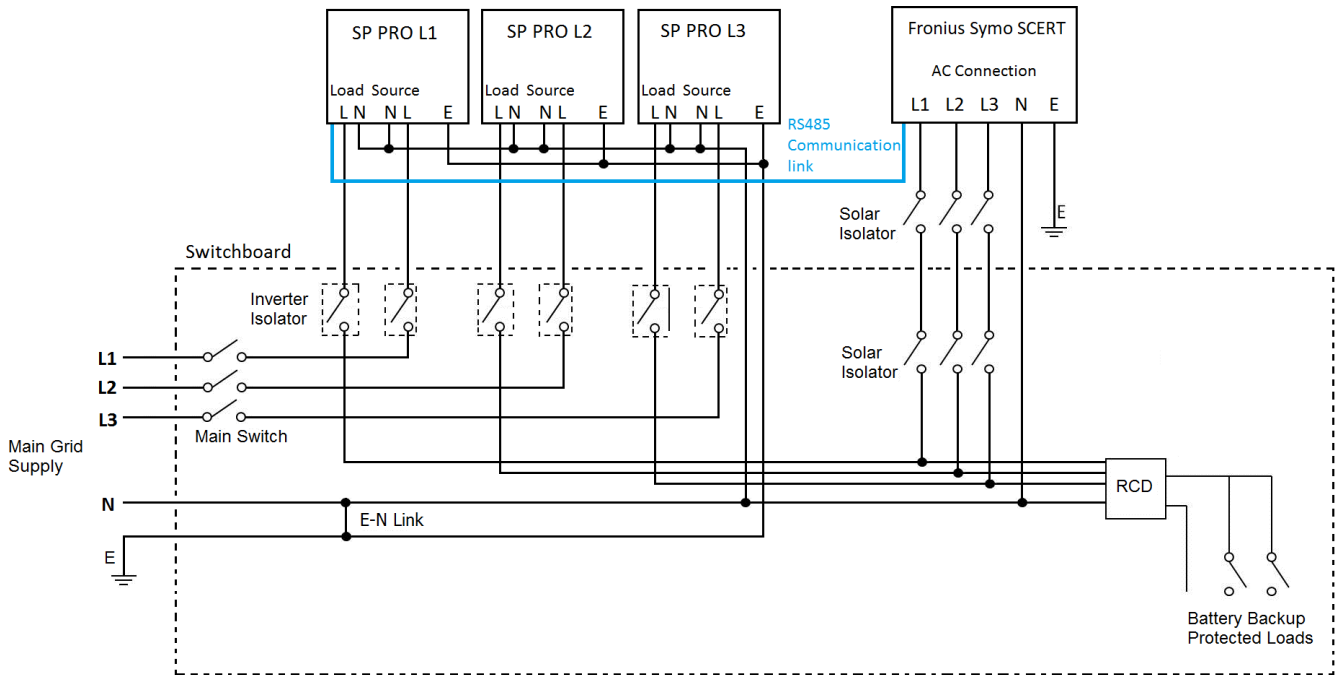

Wiring guide for Fronius Symo SCERT in a grid connected three phase system with SP PRO 2i

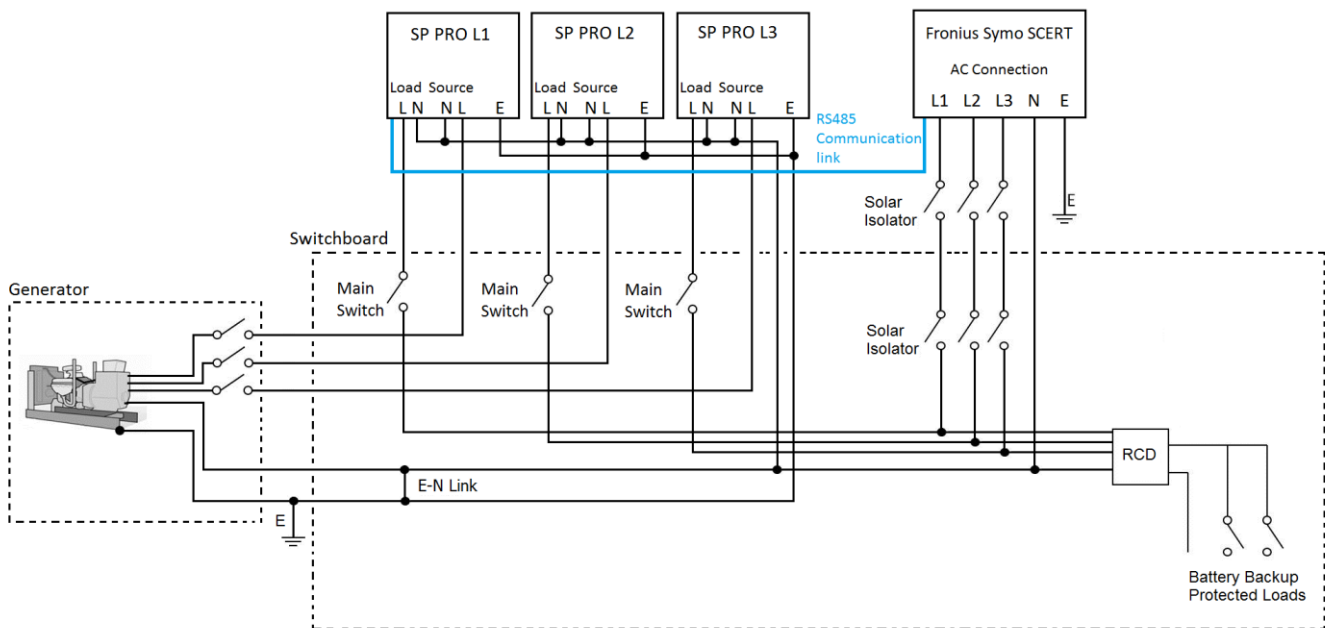

Wiring guide for Fronius Symo SCERT in an Off grid three phase system with SP PRO 2i

# SP PRO SCERT Fronius Primo or Symo Managed AC Coupling Installation Notes



## SP PRO 2i Communications Link to Fronius SCERT

The communication link always starts at the SP PRO, then connects to the first Fronius SCERT (Master). The Fronius Solar Net link is used to connect subsequent Fronius SCERTs that are controlled by the same SP PRO.

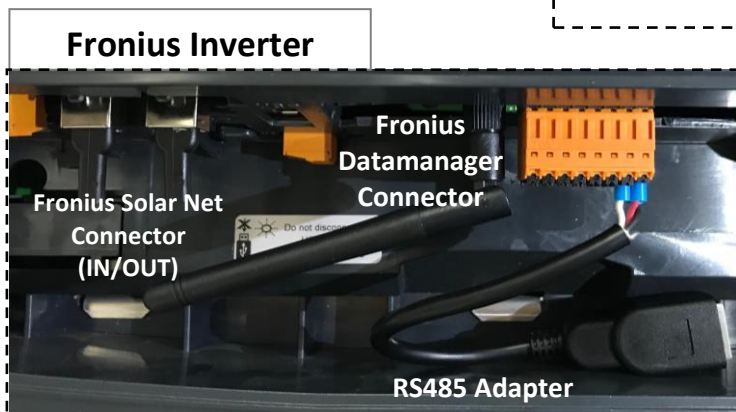
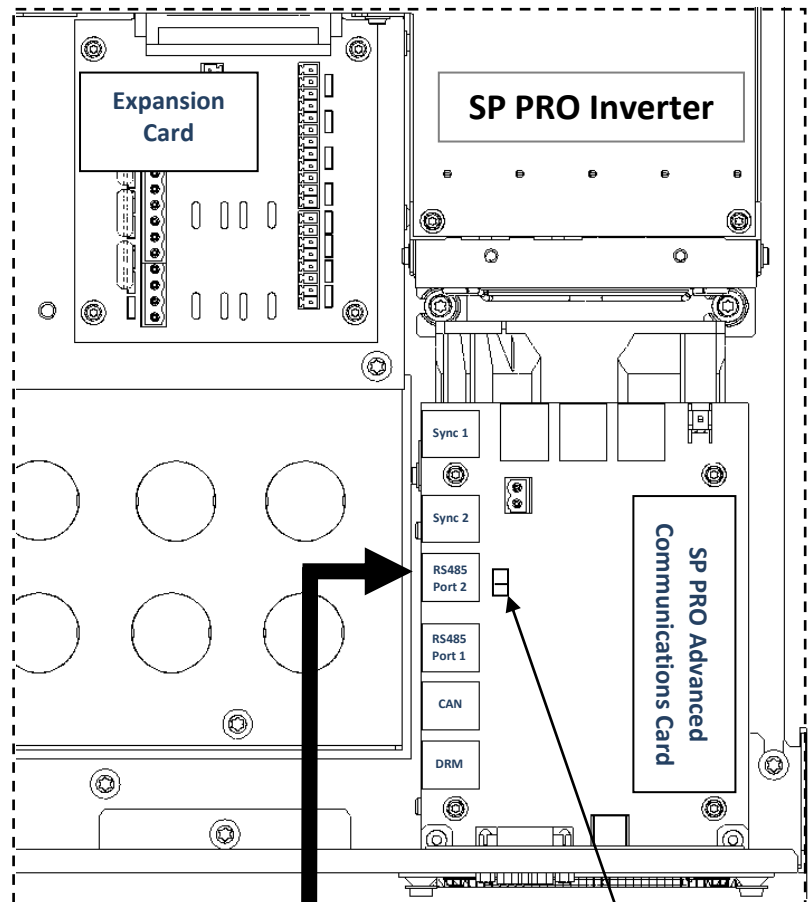

If the Comm board has a dip switch, set both switches to ON position.

*SP PRO Connections (inside unit) – RS485 Port 2 RJ45 connector to RS485 Adapter to Fronius Datamanager connector.*

*Note: See Appendix IV AC Coupled Interface (Sergio) details used within Series II SP PROs  
See Appendix VII for connection with Series I SP PROs.*

# SP PRO SCERT Fronius Primo or Symo Managed AC Coupling Installation Notes



## Connection to First Fronius SCERT (Master) Series 2i

Using the supplied 'CAT5' network cable connect one end to the RS485 Port 2 RJ45 connector on the SP PRO's Advanced Communications Card. At the Fronius SCERT 01 (Master), connect the CAT5 cable to the RS485 adapter cable that is connected to the Fronius Data Manager Connector.



To "J5 RS485-2" Port RJ45  
Connector in SP Pro

Supplied 'CAT5' Cable

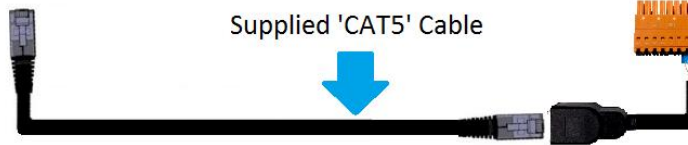

Fronius Data Manager  
Connector

RS485 Adapter Cable

**Note:** The RS485 adapter cable comes connected the Data Manager Connector within the Fronius SCERT.

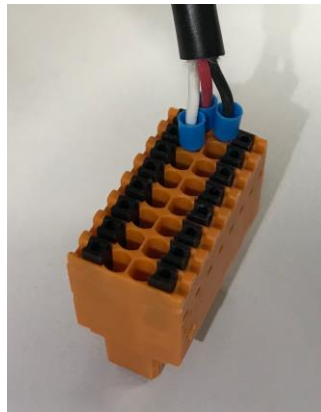

*Fronius SCERT Connections (inside unit) – RS485 Adapter Wires terminated into the Fronius Datamanager Connector.*

Wire Colour	Fronius Datamanager Connector Label
Red	D - RS485
Black	D + RS485
White	GND

# SP PRO SCERT Fronius Primo or Symo Managed AC Coupling Installation Notes



## Fronius Connection

The RS485 Adapter to the Fronius Datamanager connector has been preconnected as illustrated.

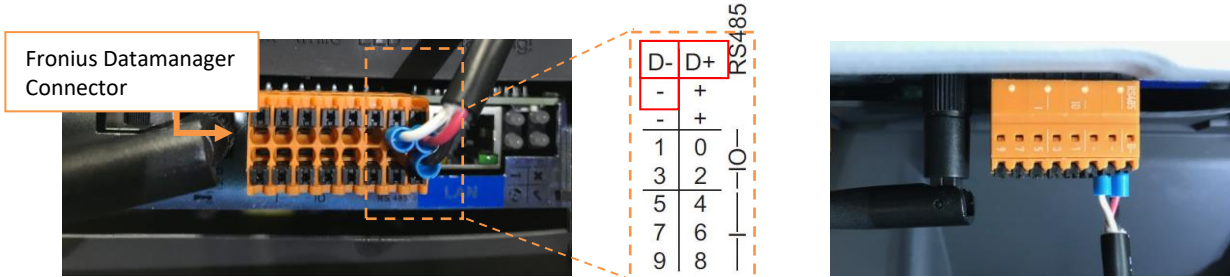

*RS485 Adapter to Fronius Datamanager connector*

For Fronius SCERT 01 only, set the Master/Slave switch (located on the left-hand side of the orange connector) to "MASTER" as illustrated.

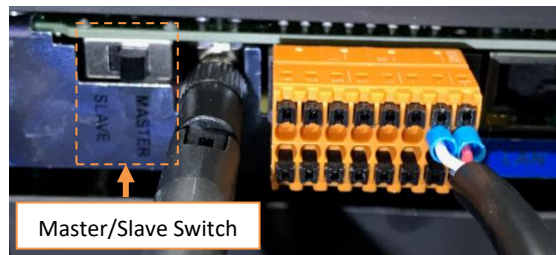

*Master/Slave switch set to "MASTER" for Fronius SCERT 01*

Make sure that the Datamanager 2.0 plug-in card – IP switch is set to position B for Fronius SCERT 01 (Master) only.

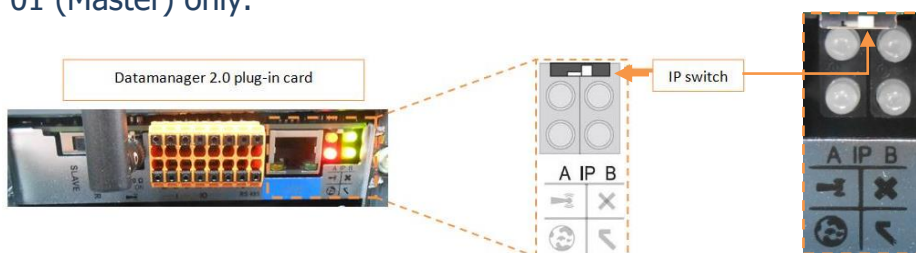

*The Datamanager 2.0 plug-in card – IP switch is set to position B*

**If only a single Fronius is installed, skip to the next section Configuration – Additional settings page 16.**

# SP PRO SCERT Fronius Primo or Symo Managed AC Coupling Installation Notes



## Connecting Fronius Solar Net link between Inverters 02 to 05

The following configuration outlines the connection for multiple Fronius Primos or Symos to the Master Fronius Inverter (Fronius Primo 01 or Fronius Symo 01).

Inside the Fronius there are two RJ45 connectors (Fronius Solar Net Connector) with termination connectors installed. The Fronius Solar Net connectors are designed to interface with multiple Fronius SCERTs in a daisy chain arrangement via the input "IN" and output "OUT" connectors.

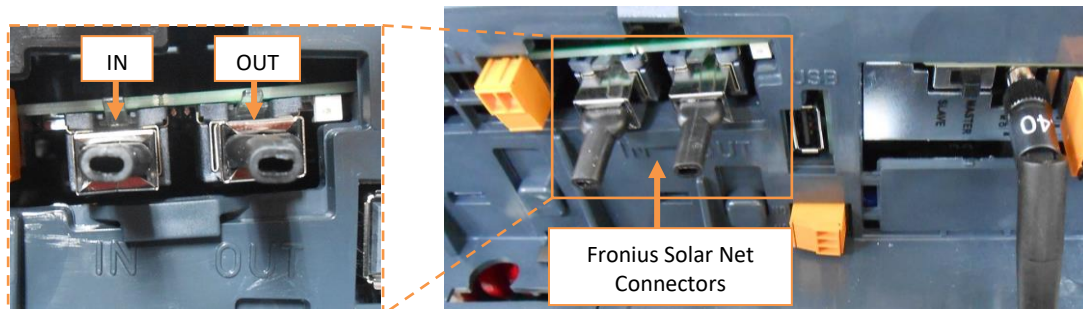

*Fronius Solar Net Connectors with termination: "IN" located on LHS & "OUT" located on RHS*

**Note:** The Fronius Solar Net Connector must be fitted to any unused connectors, or the SP PRO will not communicate to any Fronius SCERTs in the system.

Using a network patch lead connect the "OUT" (Fronius Solar Net) from Fronius SCERT 01 (Master) to the "IN" of Fronius SCERT 02.

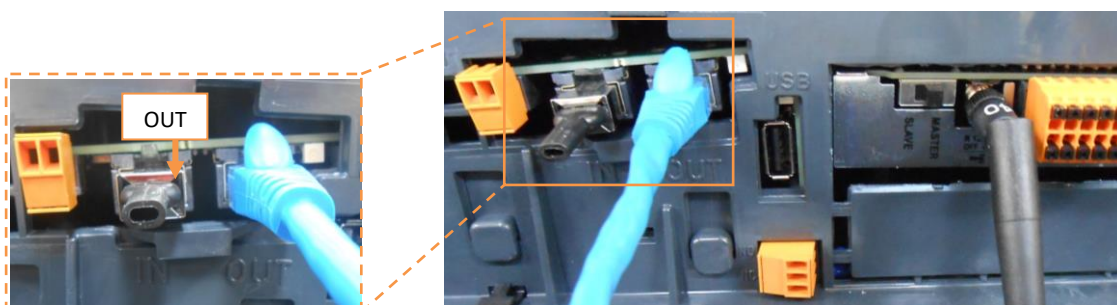

*Fronius Solar Net link - Fronius SCERT 01 "OUT"*

**The Fronius SolarNet link connects subsequent Fronius SCERTs controlled by the same SP PRO.  
Do not link together Fronius SCERTs controlled by different SP PROs.**

# SP PRO SCERT Fronius Primo or Symo Managed AC Coupling Installation Notes

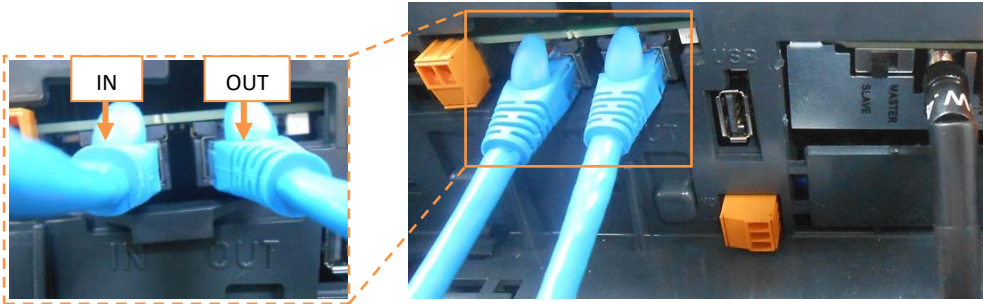

*Fronius Solar Net link - Fronius SCERT 02 "IN" & Fronius SCERT "OUT"  
(Fronius connection on intermediate inverters)*

Using another patch lead, connect the "OUT" from inverter 02 (above) to the "IN" of inverter 03 and so on until all inverters in the system are connected.

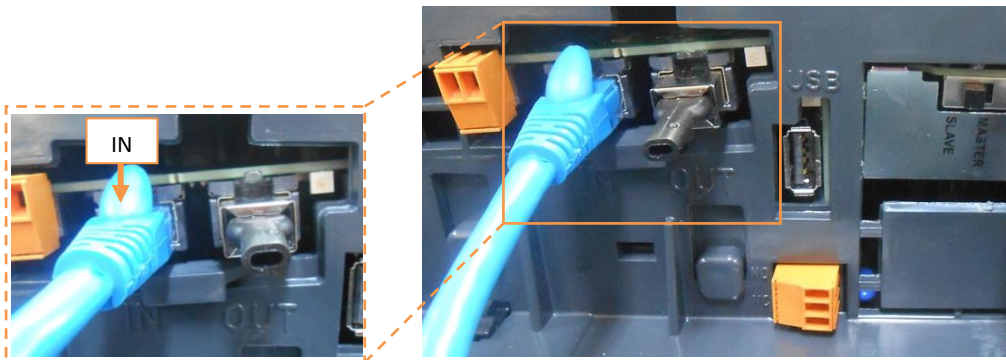

*Fronius link - Last Fronius SCERT on communication link ("IN")*

For all the inverters numbered 02 and above, set the Master/Slave switch (located on the left-hand side of the orange connector) to "SLAVE" as illustrated.

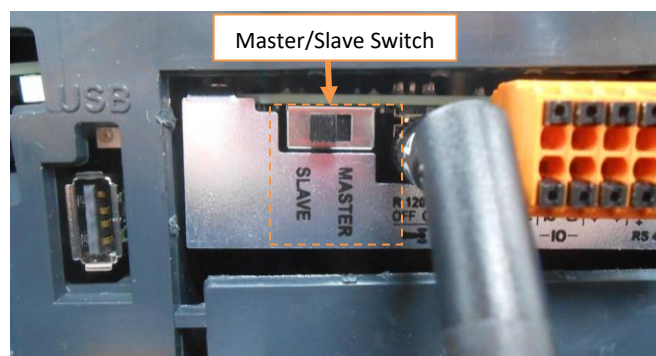

*Fronius SCERTs 02 to 05: Master/Slave switch set to "SLAVE"*

# SP PRO SCERT Fronius Primo or Symo Managed AC Coupling Installation Notes



## SP PRO Configuration – Additional Settings

The Site Configuration wizard (in SP LINK 12.11 or higher) must be used to configure the SP PRO settings. Using the wizard will ensure all SP PRO settings are compatible with the managed AC coupled system.

Only the settings required to enable Fronius Managed AC Coupling are shown.

**The SP PRO must be configured before any of the Fronius SCERTs are energised.**

Make sure in the SP LINK tab **Configuration Settings** > **System**, the follow settings are set.

- Set **String Inverter** to **Fronius**.
- **Number of Devices** is set to the number of Fronius SCERTs installed on each phase. (On Advanced Multiphase systems, each phase has its own **Number of Devices** setting.)

In the example below, two Fronius SCERTs are connected to the SP PRO.

**Note:** Port 2 Communication settings will not be available once Fronius has been enabled. This is normal operation.

Managed AC Coupled Solar

<b>String Inverter*</b> Fronius	<b>Fallback Power</b> Disabled
<b>Number of Devices*</b> [1 - 5] 2	<b>Islanding Power Limit*</b> [0.1 - 15.0 kW] 5.0 kW
<b>AC Source Limit Monitor</b> <b>Monitoring Direction</b> Export	<b>Trip Power Limit</b> [0.0 - 250.0kW] 50.00 kW
<b>Trip Time*</b> [0 - 1000 s] 5	

SP LINK - Configuration Settings – System tab

## Fronius Configuration

The settings listed below are required to be configured in each Fronius SCERT in order for the system to operate correctly.

1. Isolate the DC solar from the Fronius SCERT(s) (via the appropriate DC circuit breaker).  
Do not connect the PV solar until the system is configured.
2. Ensuring that the SP PRO AC Load supply is present at the Fronius SCERT, switch on the AC supply to the Fronius SCERT.
3. When the Fronius SCERT is powered for the first time, select the "language" for the inverter and press the **ENTER** (↵) key.





# SP PRO SCERT Fronius Primo or Symo Managed AC Coupling Installation Notes



## 4. Select Country

For both Grid Connect and Off Grid installations, scroll to **50Hz - International** (↓) and press the **ENTER** (↵) key.



## 5. Set the "Date"

Press the **ENTER** (↵) key. Use the 'UP' (+) and 'DOWN' (-) keys to shift the numerical values in an ascending/ descending order.

**Note:** "Date" will flash after the first **ENTER** (↵) key press, a second **ENTER** (↵) is required to proceed to the next step.



## 6. Set the "Time"

Press the **ENTER** (↵) key. Use the 'UP' (+) and 'DOWN' (-) keys to shift the numerical values in an ascending/ descending order.

**Note:** "Time" will flash after the first **ENTER** (↵) key press, a second **ENTER** (↵) is required to proceed to the next step.



## 7. Set the "MPP Tracker 2"

"ON" if installing more than one string of panels, otherwise set to "OFF" press the **ENTER** (↵) key

**Note:** When the Fronius SCERT is powered without the DC and the "MPP Tracker 2" is "ON", "INFO STATE 523 LOW PV VOLTAGE" will be displayed on the screen.



To enter the main menu, press the **ESC** (↵) key once, then using the **LEFT** (←) or **RIGHT** (→) keys to scroll through the main menu.

To access any of the menu items, press the **ENTER** (↵) key on the selected item.

# SP PRO SCERT Fronius Primo or Symo Managed AC Coupling Installation Notes



The **ESC** (↩) key is also used to return back to the previous menu or to edit previous digits.

The '**UP**' (↑) and '**DOWN**' (↓) keys are used to scroll through menu options or to shift numerical scales in ascending/ descending order, they are mainly used in sub menus to scroll through the various menu items.

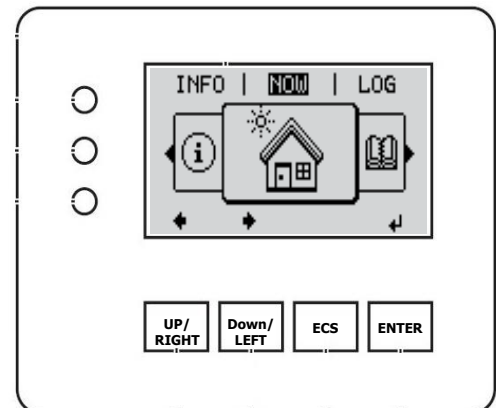

8. Access the **SETUP** menu, scroll once to the left and press the **ENTER** (↵) key. The **ENTER** (↵) key is used to confirm an action or to access submenus.

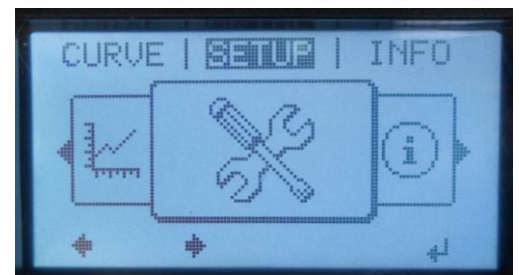

9. Scroll to **DATACOM** (↓) and press **ENTER** (↵).

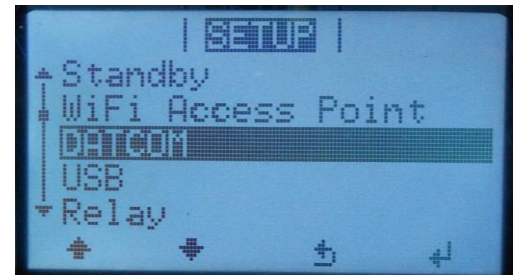

10. Scroll to **Inverter Number** (↓) and press **ENTER** (↵).

- a. If only one Fronius SCERT is installed then the address must be set to 01.
  - i. If more than one Fronius SCERT is installed then the address must be allocated sequentially starting from 01 (i.e. first Fronius = 01, second Fronius = 02, third Fronius = 03 etc).
  - ii. Do Not skip any address numbers in the sequence when using multiple Fronius SCERT
- b. Once the "Inverter Number" is selected, press the **ENTER** (↵) key to configure



## SP PRO SCERT Fronius Primo or Symo Managed AC Coupling Installation Notes



11. Scroll to Protocol Type (↓) and press **ENTER** (↵).

- a. Check Protocol Type – verify this is set to Solar Net.
- b. Press the **ENTER** (↵) key to configure and return to the “DATACOM” menu.

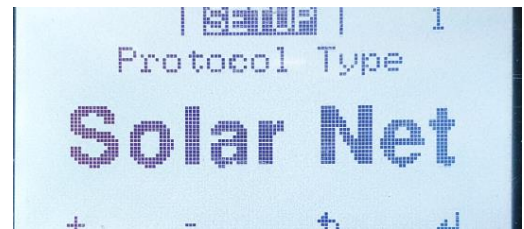

12. Press the **ESC** (↶) key twice to return to the main menu.

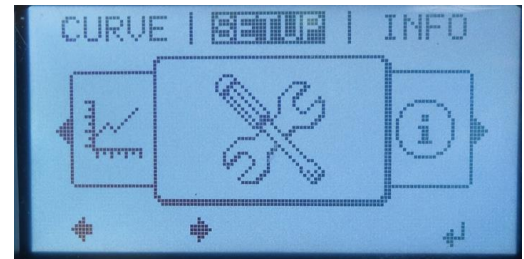

**The Fronius SCERT is fully programmed and ready for operation in a SP PRO managed AC coupled system.**

# SP PRO SCERT Fronius Primo or Symo Managed AC Coupling Installation Notes



## System Commissioning – Additional Tests

In addition to the normal system testing that would be performed, the following additional tests must be performed as detailed below.

### SP LINK Fronius SCERT 01 Communications Link Verification

The correct operation of the Fronius Managed AC Coupling relies on the communications link.

1. Check that all the communication cables have been connected correctly.
2. Connect AC to the Fronius SCERTs. Do not connect the PV until commissioning is complete.
3. Make sure that the "X" LED is Green for Fronius SCERT 01 (Master).  
If the LED is Red then the Fronius Solar Net Connector IN/OUT might not be connected correctly to all inverters (e.g. correct connection: Fronius SCERT 01 OUT connected to Fronius SCERT 02 IN...etc), or **termination connectors are not fitted**, or connectors are not plugged in correctly.



4. For SCERT 02 – 05 (SLAVE units - where installed) make sure the LED's on the Datamanager 2.0 plug-in card will be OFF.

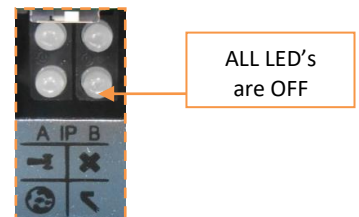

5. Using SP LINK, connect to the SP PRO. In the **Data View > Now** tab there should be a model number displayed for each of the installed inverters.

If not displayed, reset both the SP PRO and the Fronius SCERTs units by power cycling and test again.

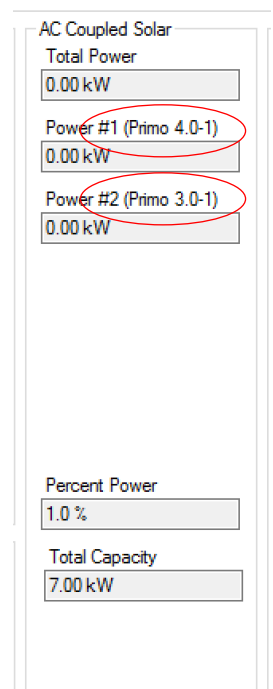

# SP PRO SCERT Fronius Primo or Symo Managed AC Coupling Installation Notes



6. In the Service Settings tab click the “Reset Counters” button  
Wait 2 minutes and check that the error count remains at zero for all the connected Fronius SCERTs.

An error count of 5 or less per minute is acceptable but, in this case, it is good practice to check the wiring and that the termination resistors are set correctly in the SP PRO and Fronius SCERTs.

Once the Communications link has been verified for each Fronius SCERT, switch the DC feeds to each inverter on and perform the verification steps below.

## Verification of Fallback Mode:

When the Fronius SCERT loses communications with the SP PRO, the output of the all the Fronius SCERTs will drop to zero power after 10 seconds.

1. To verify this function, disconnect the communications lead between the SP PRO and Fronius SCERT, wait 10 seconds.

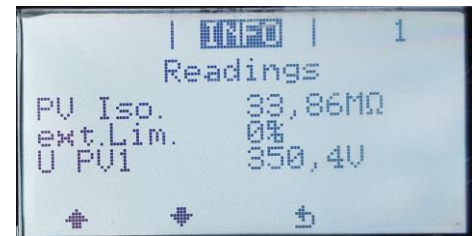

Go to **INFO** > **Readings** menu on the front display of the first Fronius SCERT and check that the external limit (ext. Lim.) drops to 0%.

## Verification of Fronius FailSafe Mode:

When the Fronius Solar Net connection faults, the Fronius units must revert to FailSafe mode and stop producing power.

1. To verify this function, disconnect the Solar Net cables between the Fronius SCERT units – if only one, unplug the Solar Net termination plug.
2. Select the NOW screen on the Fronius Inverter. If there are more than one error message then use the ‘UP’ (↑) and ‘DOWN’ (↓) keys to display each one.



All units must display  
“Error State 710 – Alive Signal Fail”.

See **Appendix V: Fronius FailSafe Configuration** to adjust Fronius settings if this does not occur.

**All of the additional tests required are now complete, the full system and commissioning can now be completed.**

# SP PRO SCERT Fronius Primo or Symo Managed AC Coupling Installation Notes



## Appendix I: Connecting to Datamanager Card

The settings below are required to connect the Fronius SCERT to the end device (e.g. Laptop) for monitoring and communication to the Fronius SCERT. The settings are ONLY carried out for Fronius SCERT 01 (Master).

**Note:** This section needs to be read in conjunction with the Fronius Datamanager 2.0 manual. Fronius Solar Net termination connectors must be inserted into each empty IN or OUT Solar Net connector socket of the last inverter.

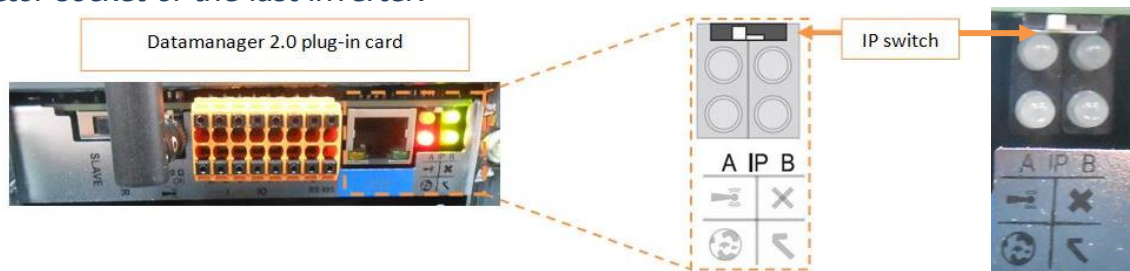

The IP switch must be set to position A (for Ethernet) or B (for WiFi)

### Option 1: Connecting via WiFi -

1. Set the IP Switch to position B for Fronius SCERT 01.
2. From the main menu, scroll to **SETUP** and press the **ENTER** (↵) key.
3. Scroll to **Wi-Fi Access Point** (↓) and press **ENTER** (↵).

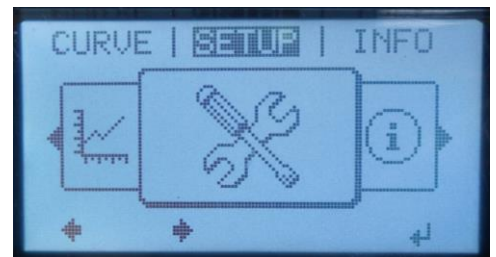

3. Scroll to **Wi-Fi Access Point** (↓) and press **ENTER** (↵).

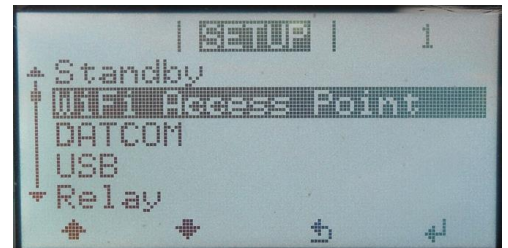

4. Select "Activate Wi-Fi AP?" and press **ENTER** (↵).

**Note:** "Activate Wi-Fi AP?" will take a couple of seconds to appear on the screen.

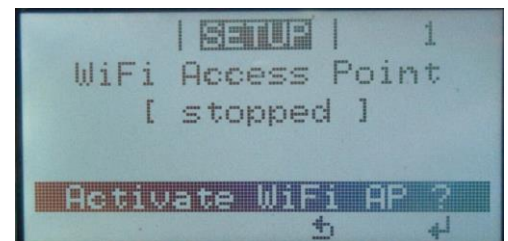

5. The "WiFi Access Point" will activate automatically "active" and the Network Name "SS" and Password "PW" will be displayed on the screen.

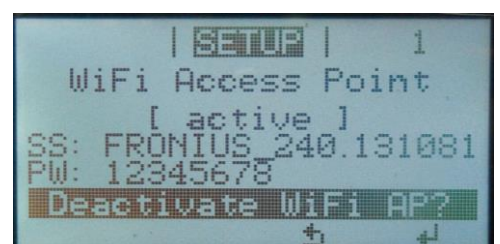

### Notes:

- DO NOT select "Deactivate WiFi AP?", the Wi-Fi signal will be lost.
- The WLAN Wi-Fi signal stays open for one hour.
- If "[active read only]", set IP switch to position "B".

# SP PRO SCERT Fronius Primo or Symo Managed AC Coupling Installation Notes



- From the end device, search for the Network Name displayed on the Fronius SCERT and establish a connection to the network. The password network is displayed on the LCD display of the inverter (Default PW: 12345678).

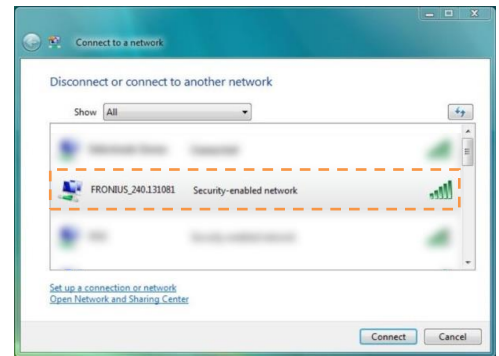

**Note:** No internet is required. The Fronius SCERT establishes a direct Wi-Fi connection between the end device and itself.

**Note:** If using a Tablet, download the **Fronius Solar.web App** from Google play or App Store.

- Open an internet web browser and type the IP address:

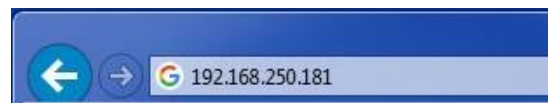

- IP address for WLAN connection: 192.168.250.181

**Fronius web interface will now be display**

## Option 2: Ethernet LAN Connection

- Set the IP switch on the Datamanager 2.0 plug-in card to **position A** on **only** Fronius SCERT 01 (Master).



**Note:** Make sure to set the IP switch back to position B when the "Modbus Communication & Fall-Back Function Setting" section is complete otherwise the Fronius SCERT will not communicate to the SP PRO.

To end device (e.g. computer or laptop)

- Connect a network cable from the Ethernet connector located on the Fronius SCERT to an end device (e.g. computer or laptop).



- Open an internet web browser and type the IP address:

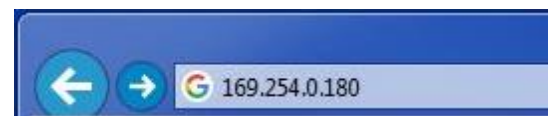

- IP address for LAN connection: 169.254.0.180

**Fronius web interface will now be display**

**Note:** Make sure that the computer is **NOT** connected to the internet.



# SP PRO SCERT Fronius Primo or Symo Managed AC Coupling Installation Notes



## Datamanager web page interface

**Note:** If using a Tablet, Run the Fronius Solar.web App.

1. The Fronius Datamanager 2.0 website start page appears

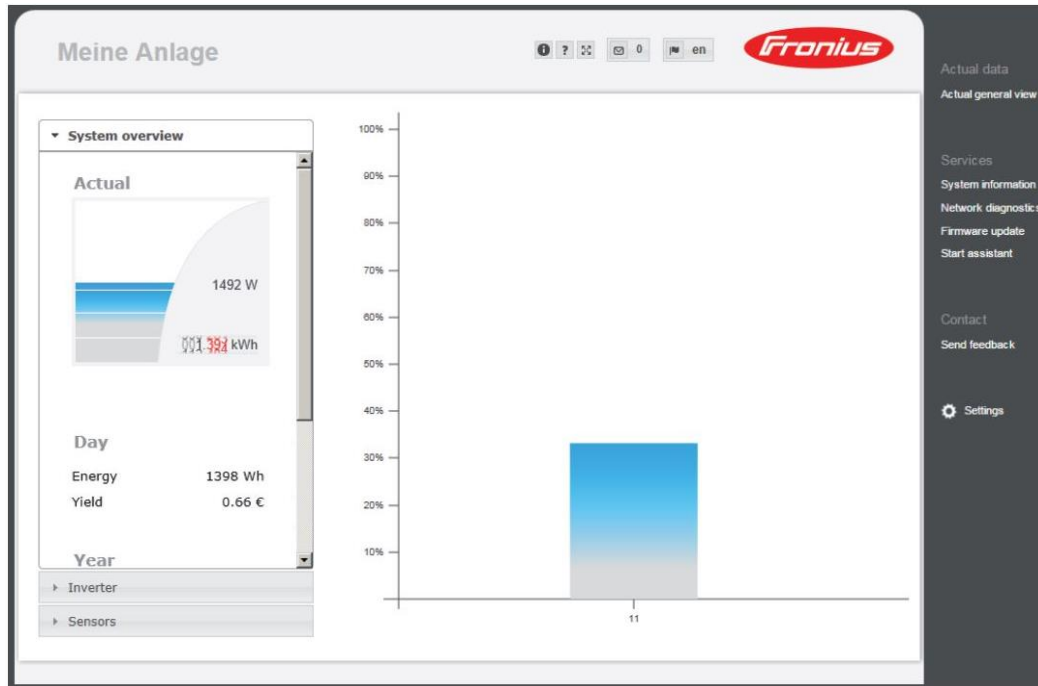

**Note:** The image is used as an example only, settings may differ.

2. Defaults for the setting menu in the Fronius Datamanager 2.0 website  
Username: **admin** password: **selectronic**
3. Defaults for the setting menu in the "DNO EDITOR"  
Username: **service** password: **selectronic**

### **Note:**

- a. Both the admin and service username and password are configured for Fronius SCERT SCERT Managed AC coupling inverters **ONLY**.
- b. In "settings" it is required to update the "GENERAL" tab and "INVERTERS" tab with the appropriate information.



# SP PRO SCERT Fronius Primo or Symo Managed AC Coupling Installation Notes



## Appendix II: Fronius Datamanager Configuration

This is required when dealing with Fronius that have had configuration changes made.

Connect to the unit via WiFi or LAN connection first – See Appendix I.

1. Complete the "General" section with the appropriate information, then select "Forward".

The screenshot shows the 'System monitoring' interface with the 'General' tab selected. The 'System name' field is empty. Under 'Yield', the 'Feed-in tariff' is set to 0.01 \$ (AUD) /kWh and the 'Grid supply tariff' is set to 0.01 /kWh. The 'System time' is set to 07/28/2017 08:14 AM. The 'Time zone settings' are set to Australia, Melbourne. There are 'Back' and 'Forward' buttons at the bottom.

2. In the "Inverter" section, **Device name** and **PV[Wp]** are required. Select "Forward".

The screenshot shows the 'System monitoring' interface with the 'Inverter' tab selected. The 'System name' field is empty. There is a 'Set all' button. A table lists the inverter configuration:

No	visible	Device type	Device name	PV[Wp]
3	<input checked="" type="checkbox"/>	Primo 3.0-1	* Primo 3.0-1 (3)	*

There are 'Back' and 'Forward' buttons at the bottom.

# SP PRO SCERT Fronius Primo or Symo Managed AC Coupling Installation Notes



3. A notification will appear before the next section. You must click "Accept" to proceed.

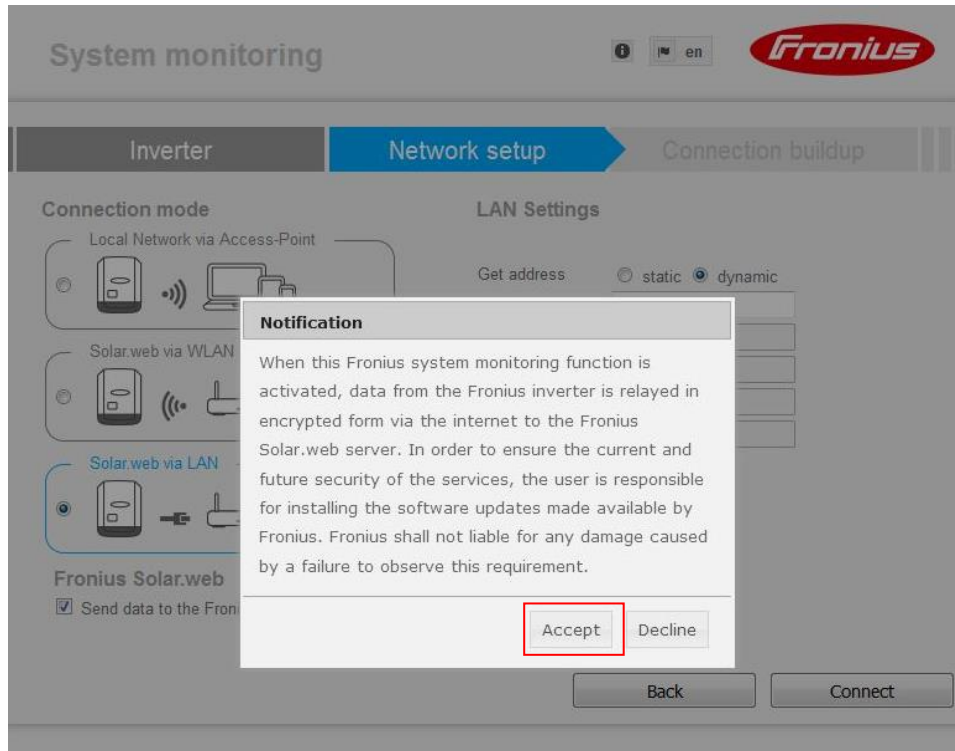

4. Select "Solar web via LAN" and then select "Connect".

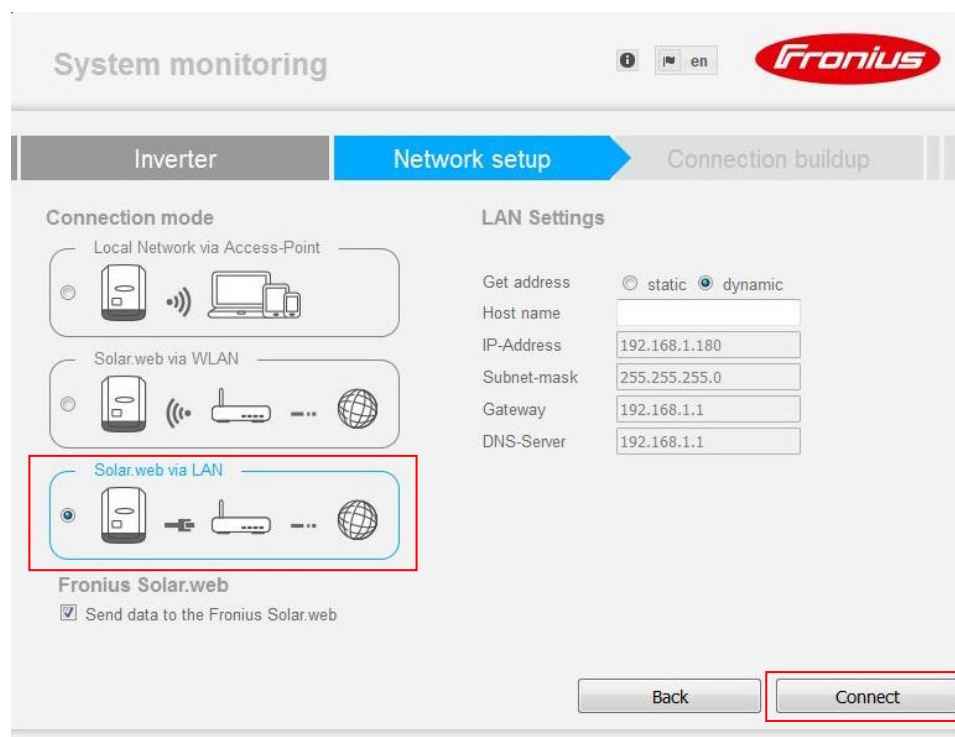

# SP PRO SCERT Fronius Primo or Symo Managed AC Coupling Installation Notes



5. When "Connect" is selected, "Connection buildup" will be displayed.

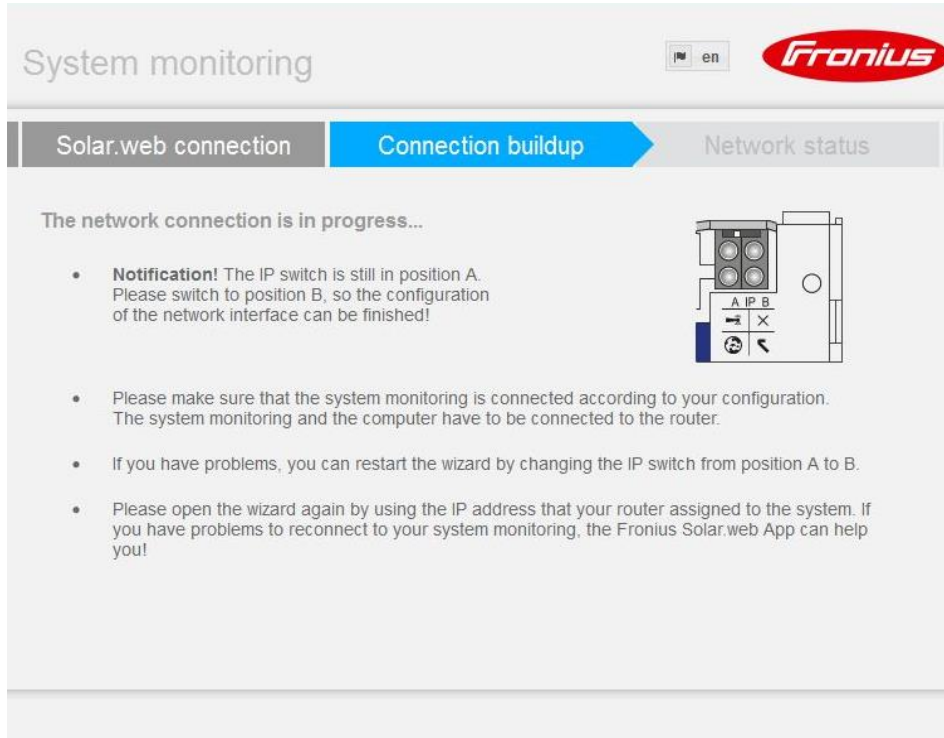

- Set the **IP Switch** to **position B** and then refresh the webpage.
- Wait for one second.
- Then set the **IP Switch** back to **position A** and then refresh the webpage.

**Note:** When the Fronius SCERT is reconnected to the end device (e.g. computer or laptop), the wizard will automatically proceed to the next section.

# SP PRO SCERT Fronius Primo or Symo Managed AC Coupling Installation Notes



6. The "Network status" outlines the network detail. Select "Forward".

The screenshot shows the 'System monitoring' interface with the 'Network status' tab selected. It displays network configuration details for LAN and Internet. The LAN section shows IP-Address: ---, Network mask: ---, and MAC address: 00:03:AC:0A:B2:6E. The Internet section shows available: No, Name server: ---, and Gateway: ---. A message box states: 'You are in configured network of the monitoring system. You can continue the wizard now.' Buttons for 'Back' and 'Forward' are at the bottom.

7. A password is required to be setup. Create a password that is easy to remember and contains both letters and numbers and select "Finish".

The screenshot shows the 'System monitoring' interface with the 'Passwords' tab selected. It prompts the user to set an administrator password. The 'User name' field contains 'admin'. The 'Password \*' field has a yellow 'acceptable' button. The 'Repeat password \*' field has a green 'identical' button. A checkbox for 'Protect your system monitoring from unauthorized read access.' is present. Buttons for 'Back' and 'Finish' are at the bottom. A notification at the bottom states: 'Notification! The password should include numbers and special characters.'

# SP PRO SCERT Fronius Primo or Symo Managed AC Coupling Installation Notes



8. The Commissioning Wizard is complete. Select "To Homepage".

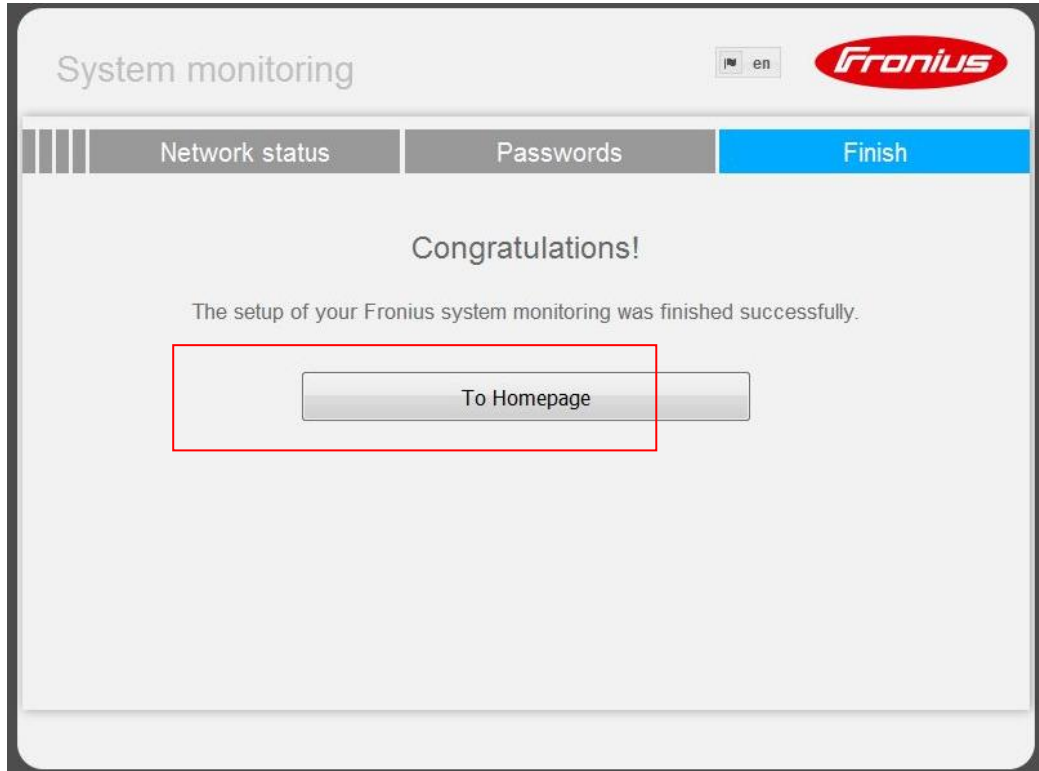

9. When "To Homepage" is selected, the Fronius Datamanager 2.0 website start page appears.

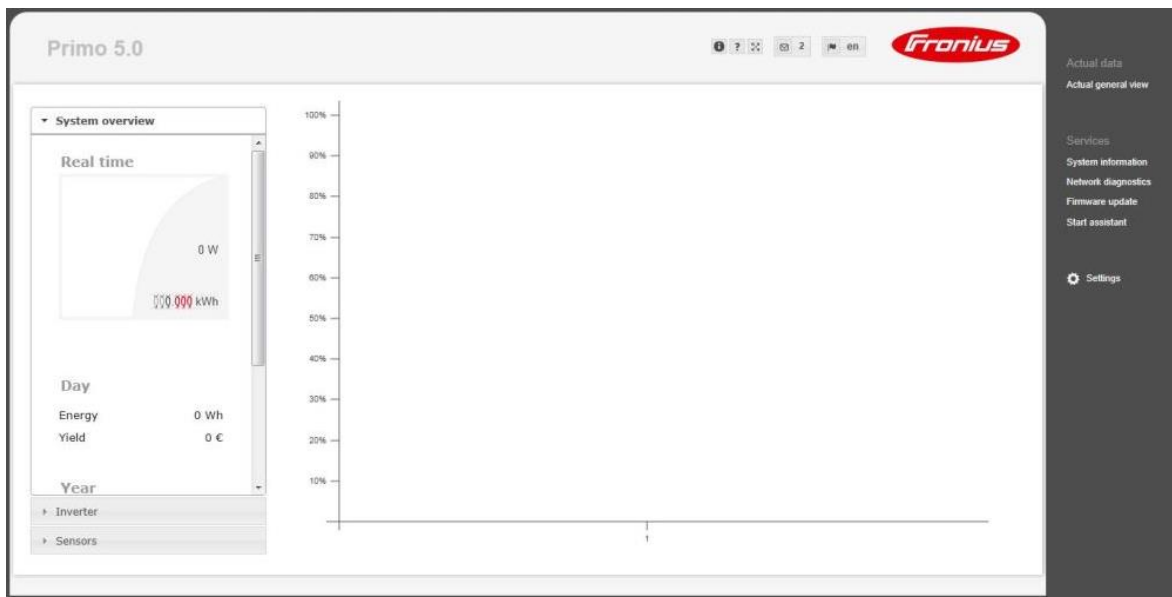

**Note:** The image is used as an example only, settings may differ.

# SP PRO SCERT Fronius Primo or Symo Managed AC Coupling Installation Notes



10. On the Datamanager 2.0 website, select "Settings".

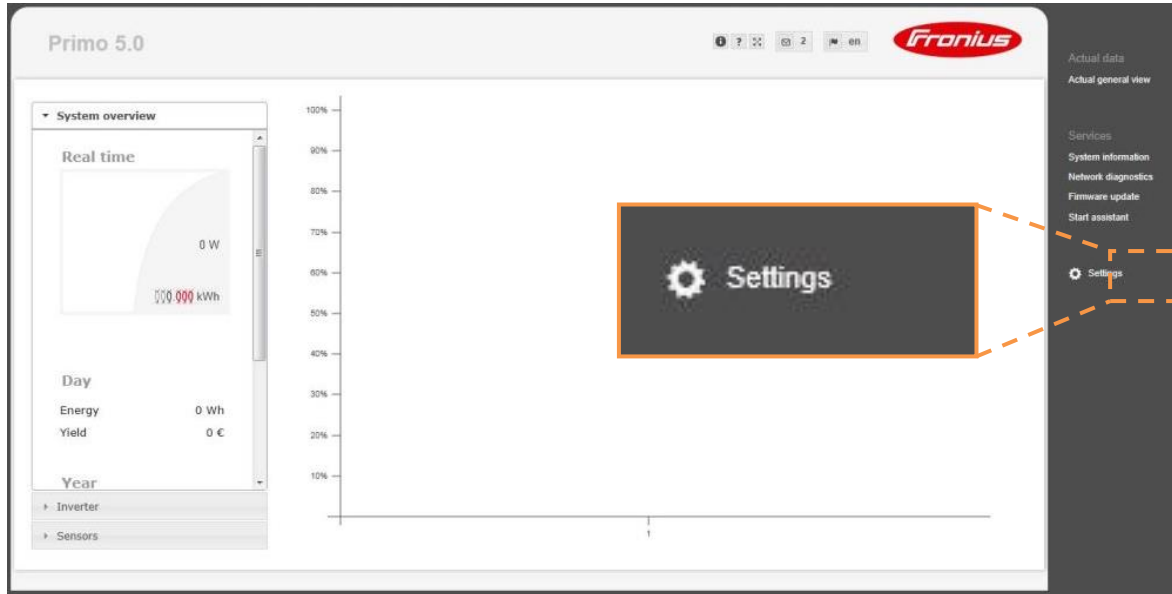

**Note:** The image is used as an example only, settings may differ.

11. Select the "PASSWORDS" tab.

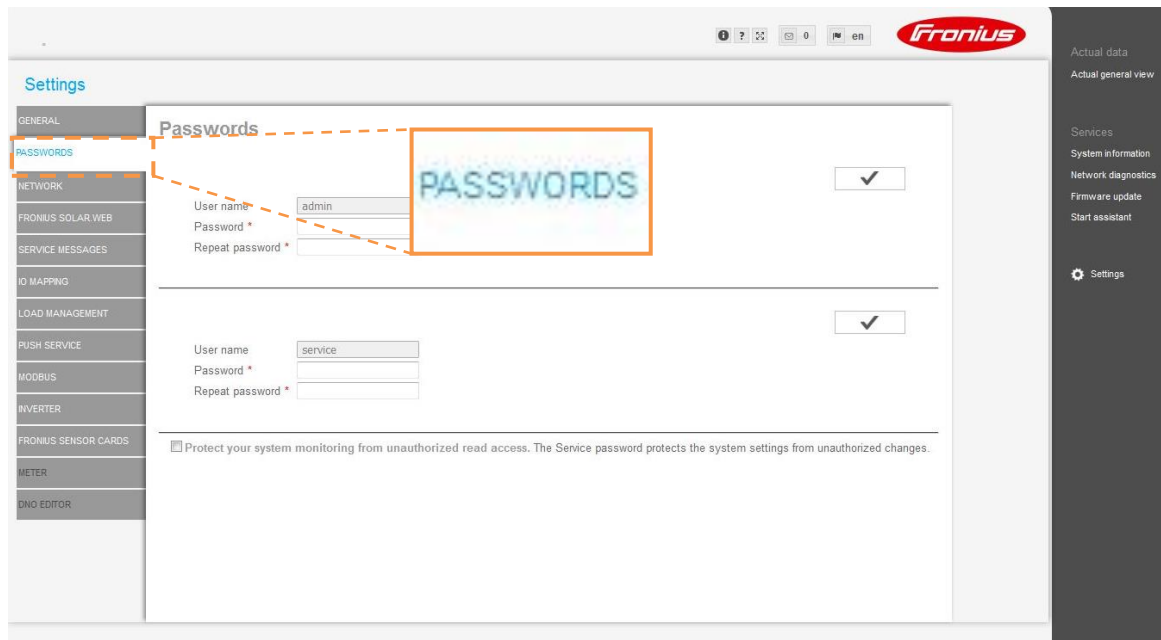

12. Under "User name service", create a password that is easy to remember and contains both letters and numbers.

**Note:** The service password is required to access the "DNO EDITOR" tab

# SP PRO SCERT Fronius Primo or Symo Managed AC Coupling Installation Notes

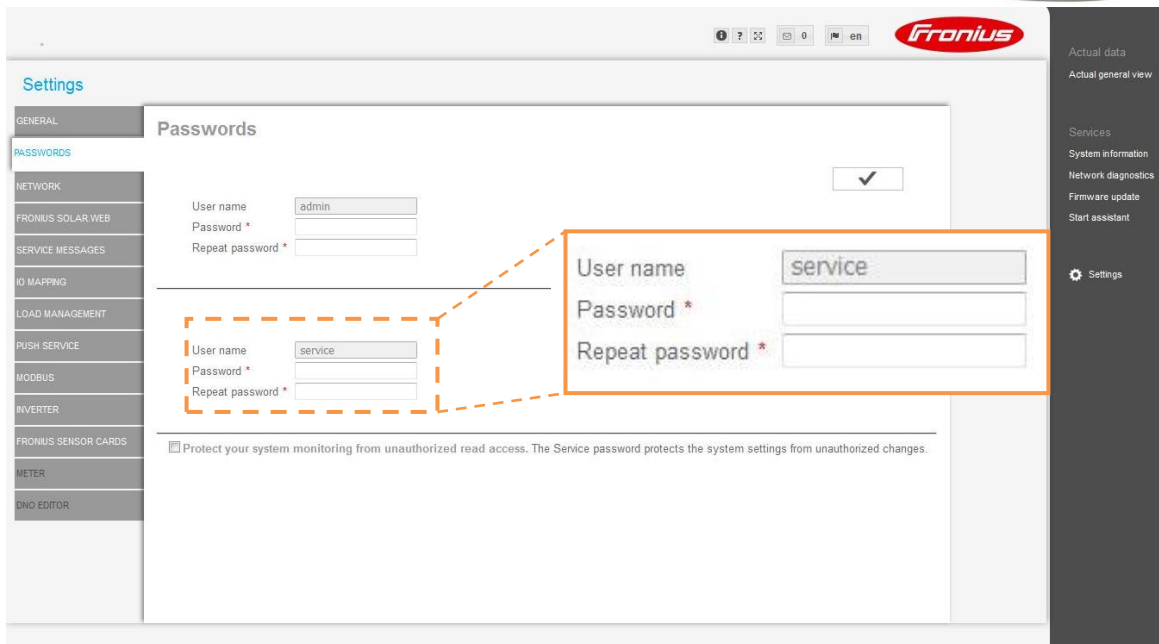

**Note:** The image is used as an example only, settings may differ.

Default login: Username **service**: password **selectronic**

13. Save the changes made in "PASSWORDS" by selecting the tick (✓) in the top right-hand corner of the page. A popup message will appear to indicate the changes made were saved.

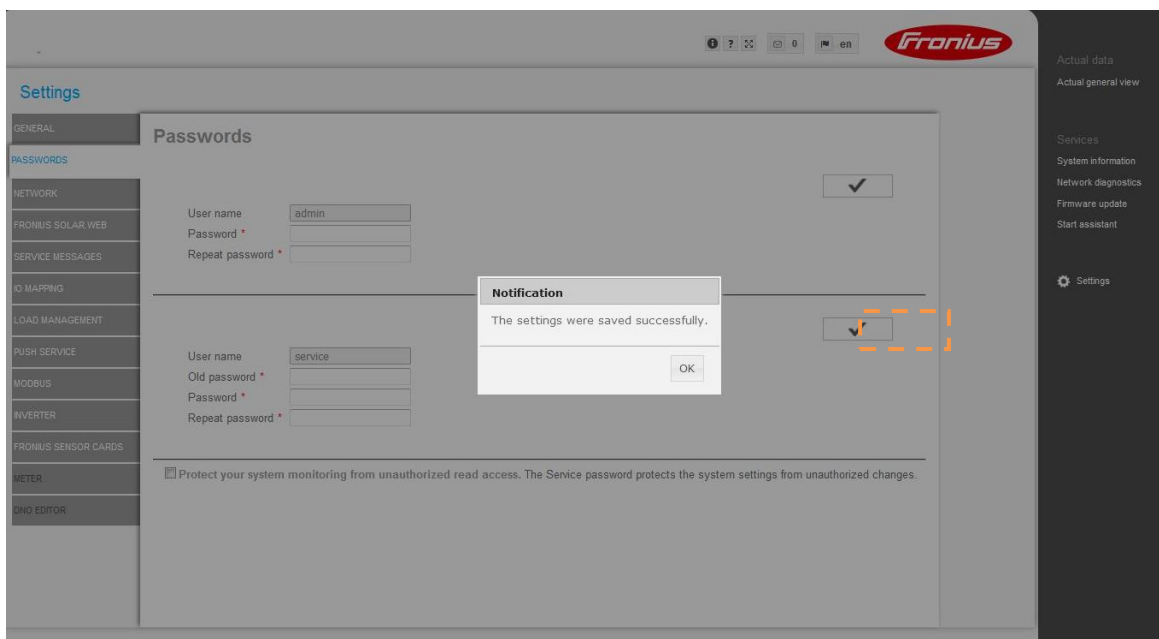

# SP PRO SCERT Fronius Primo or Symo Managed AC Coupling Installation Notes



14. Select the "DNO EDITOR" tab.

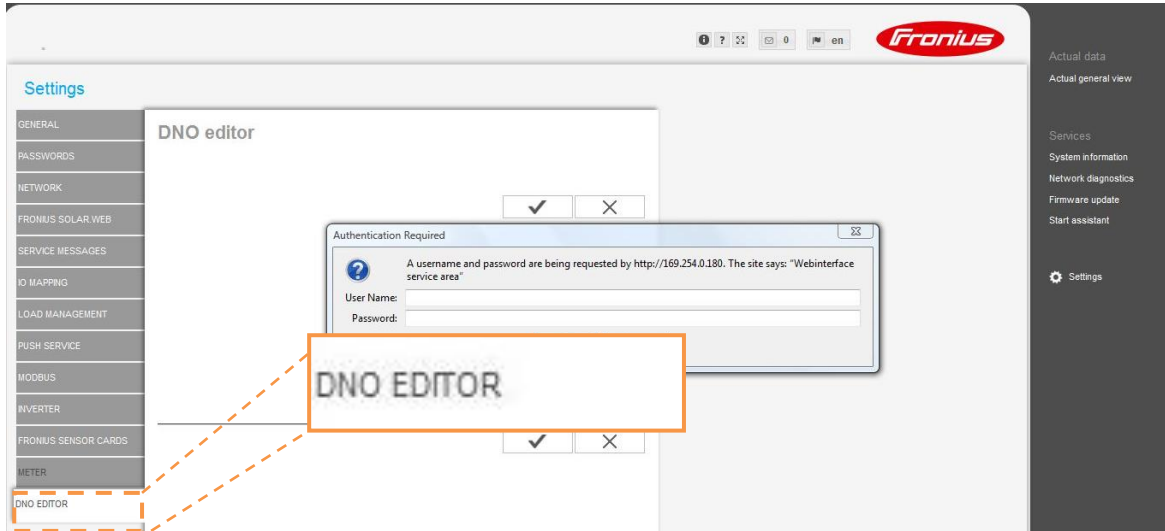

15. A user name and password are required to access the "DNO EDITOR" tab. Enter the service username and password created in step "12", select "OK".

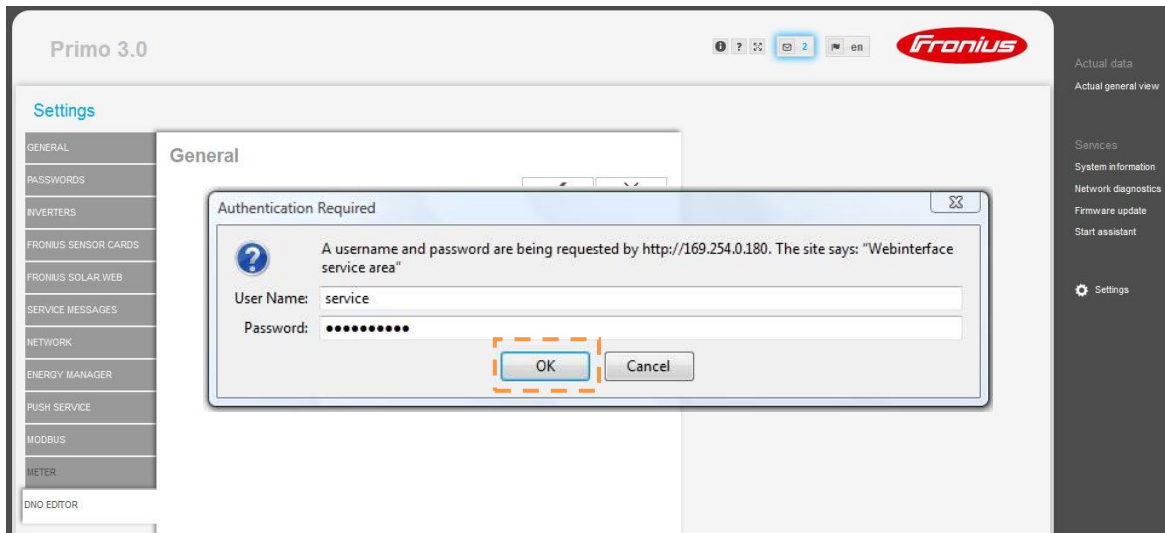



# SP PRO SCERT Fronius Primo or Symo Managed AC Coupling Installation Notes



16. In the "IO Control" table, toggle the boxes in "I4" column and the fourth row to white.

The screenshot shows the 'DNO editor' interface with the 'IO control' table. The table has columns for 'Input pattern' and 'Active power'. The fourth row is highlighted with an orange box, and the 'I4' column is also highlighted with an orange box. The 'Active power' for the fourth row is set to 0%.

Input pattern	Active power
100 %	100 %
60 %	60 %
30 %	30 %
0 %	0 %

17. Make sure that the "Active power" for the fourth row is 0%.

The screenshot shows the 'DNO editor' interface with the 'IO control' table. The fourth row is highlighted with an orange box, and the 'Active power' column is also highlighted with an orange box. The 'Active power' for the fourth row is set to 0%.

Input pattern	Active power
100 %	100 %
60 %	60 %
30 %	30 %
0 %	0 %

# SP PRO SCERT Fronius Primo or Symo Managed AC Coupling Installation Notes



18. Save the changes made in "DNO EDITOR" by selecting the tick (✓) in the top right-hand corner of the page. A popup message will appear to indicate the changes made were saved "The settings were saved successfully".

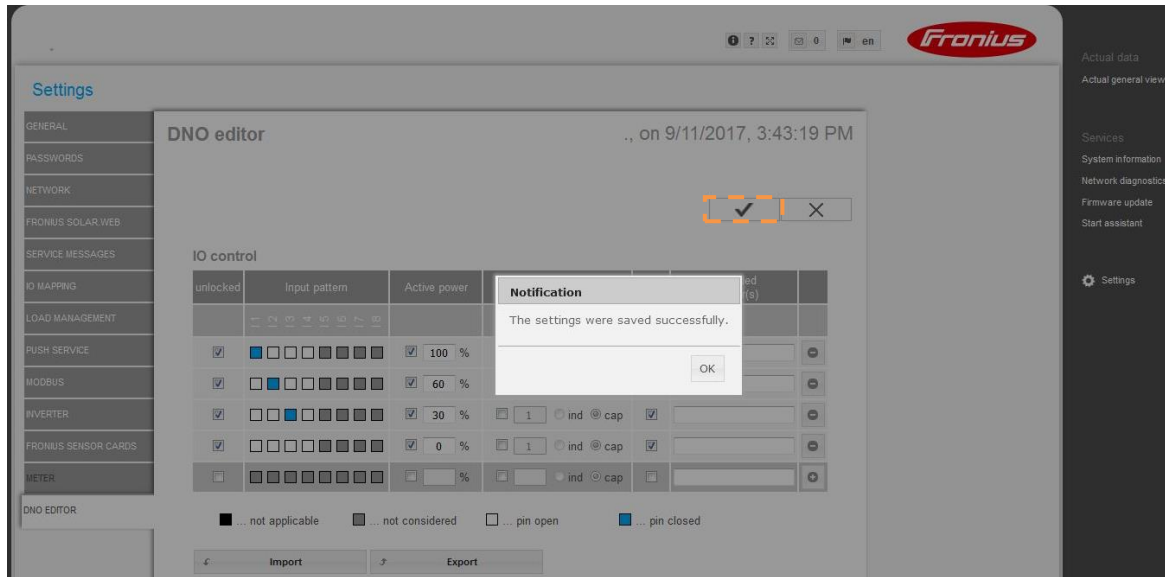

19. In "DNO EDITOR" tab, scroll down to "Controlling Priority" and set:

- ii. "IO control" to 2
- iii. "Dynamic power reduction" to 3
- iv. "Controlling via Modbus" to 1

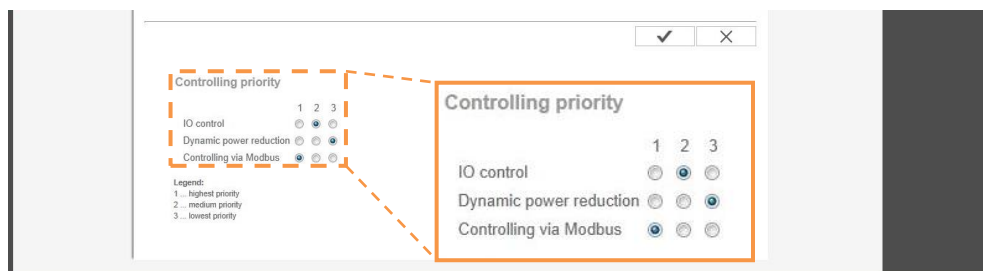

# SP PRO SCERT Fronius Primo or Symo Managed AC Coupling Installation Notes



20. Save the changes made in “DNO EDITOR” by selecting the tick (✓) in the top right-hand corner of the page. A popup message will appear to indicate the changes made were saved “The settings were saved successfully”.

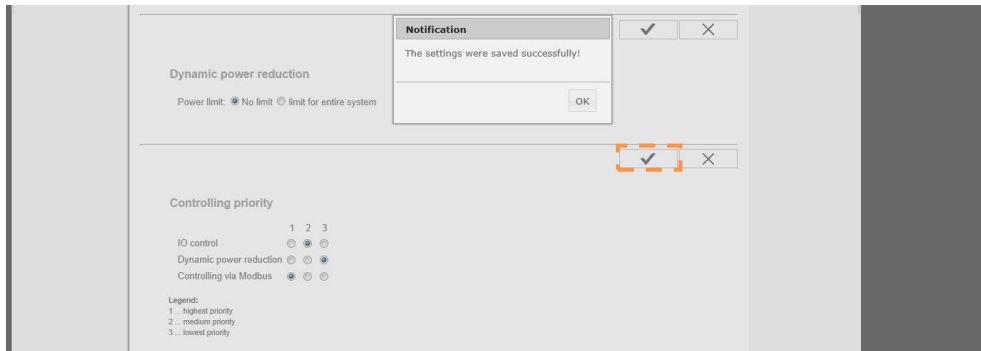

21. Check the Modbus settings – settings must be as below -

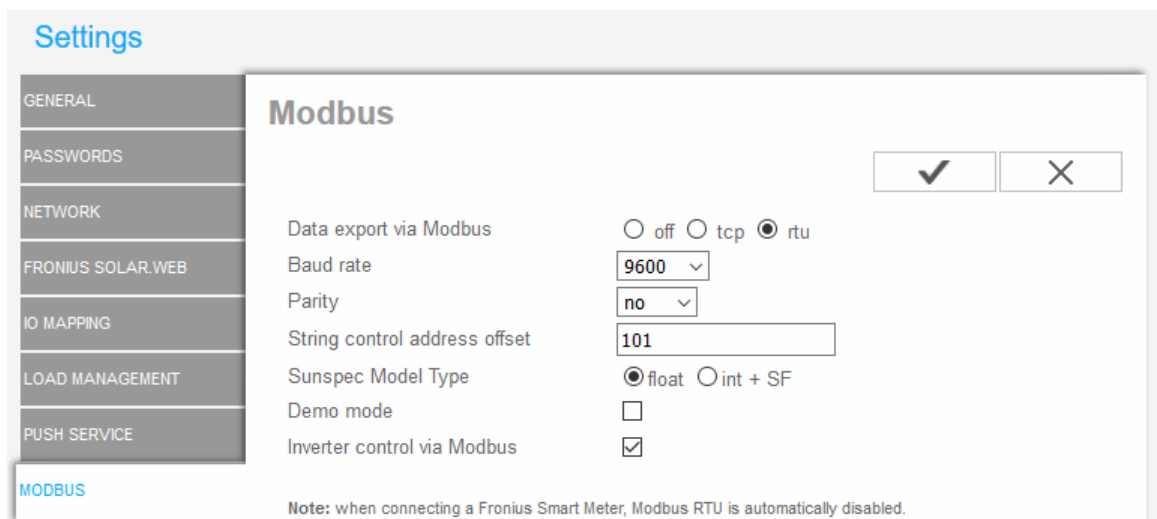

22. Carry out the System Commissioning on Page 19.

## Fronius configuration is now complete

**Note:** On Fronius SCERT 01 (Master), make sure the IP switch is in position 'B', otherwise the Fronius SCERT will not communicate to the SP PRO.



## Appendix III: Disable Fronius Smart Meter

If the Fronius SCERT has been connected to an external smart meter, the internal Fronius Smart Meter must be disabled. Follow the instructions below to disable.

The Fronius Datamanager webpage can be accessed in two ways:

### 1. Wi-Fi connection:

- Activate the Wi-Fi Access Point on the Datamanager card, can be accessed via the front panel display.
- Connect the computer or smart device to the "Fronius\_240.XXXXXX" Wi-Fi network. The Wi-Fi Password is 12345678.
- Open an internet web browser and go to <http://192.168.250.181>

Alternatively, can use Fronius SolarWeb App (Tablet/Smart Phone), go to '**Settings**' and click '**PV Inverter Homepage**' (IOS) or **My System Monitoring** (Android)

### 2. LAN connection:

- Connect the computer to the Datamanager via a network cable.
- Set the Datamanager IP Switch to position "A".
- Open an internet web browser and go to <http://192.254.0.180>

**Note:** For information on how configure the Datamanager card for Wi-Fi and LAN connection, refer to Appendix I (page 22).

When the Fronius Datamanager webpage appears, select "Settings".

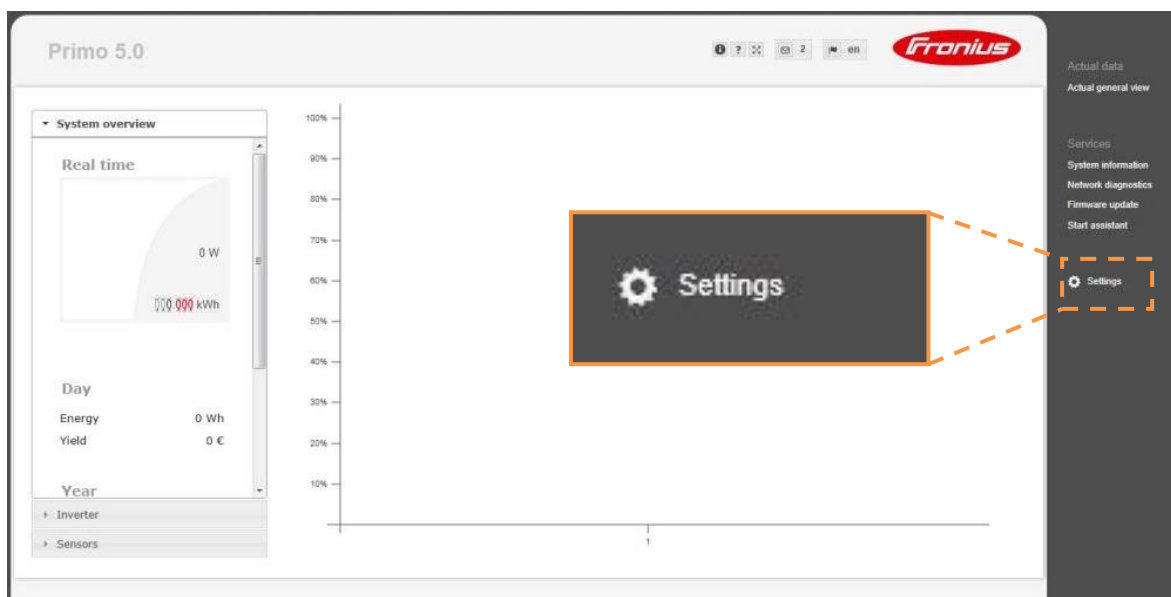

**Note:** The image is used as an example only, settings may differ.

# SP PRO SCERT Fronius Primo or Symo Managed AC Coupling Installation Notes



Make sure the Service password is configured in order to access the "METER" and "DNO EDITOR".

Select the "METER" tab.

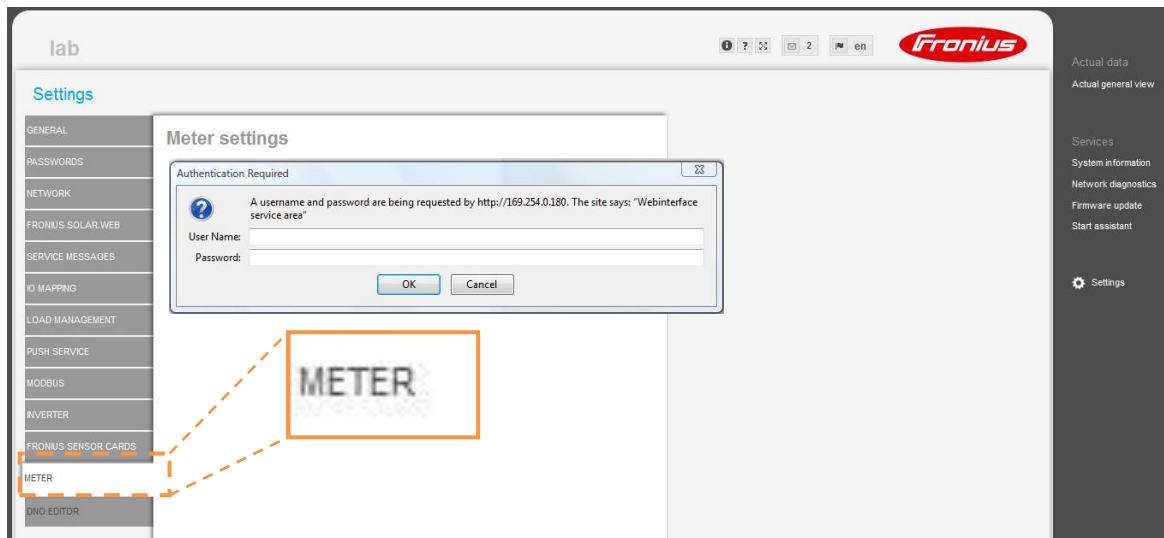

A user name and password are required to access the "METER" tab. Enter the service username and password created and then select "OK".

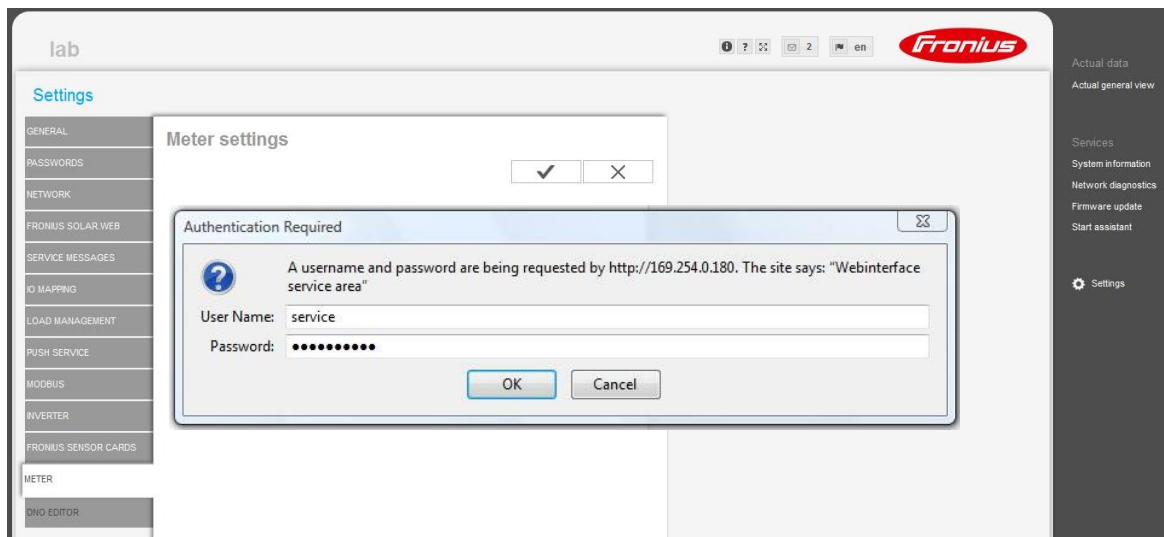

# SP PRO SCERT Fronius Primo or Symo Managed AC Coupling Installation Notes



Set the "Meter" to "None selected" and select the tick (✓) to save all changes.

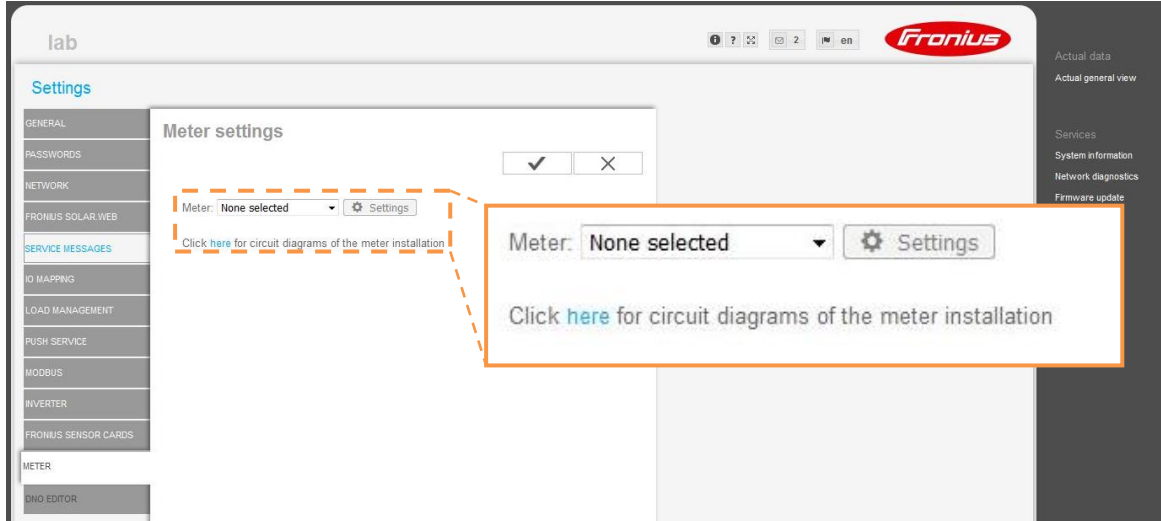

Select the "DNO EDITOR" tab.

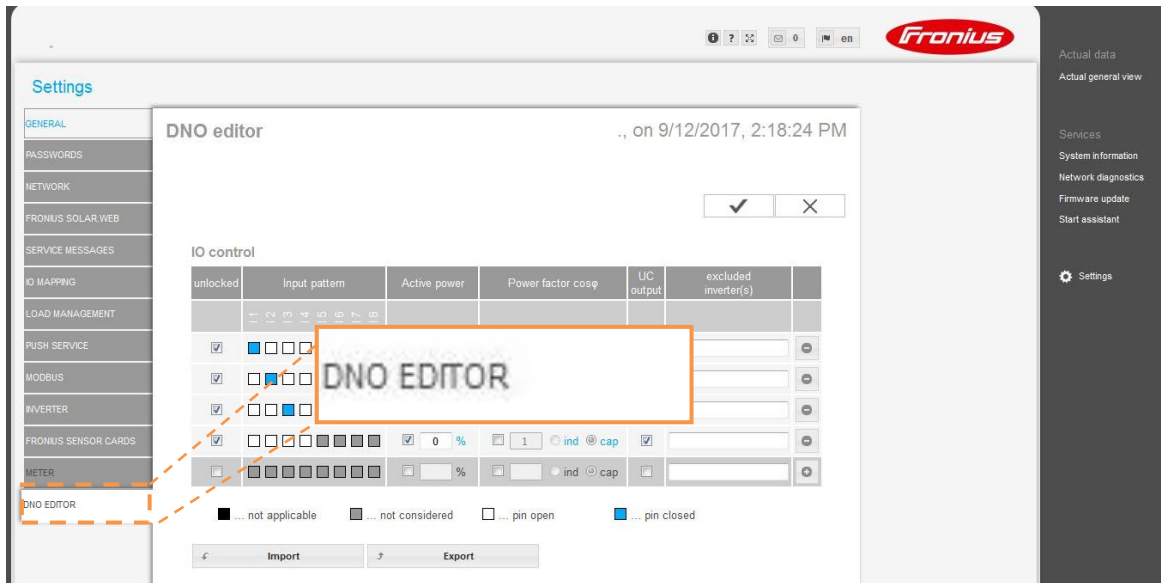

# SP PRO SCERT Fronius Primo or Symo Managed AC Coupling Installation Notes



Scroll down to “Dynamic power reduction” and set to “No limit”, select the tick (✓) to save all changes.

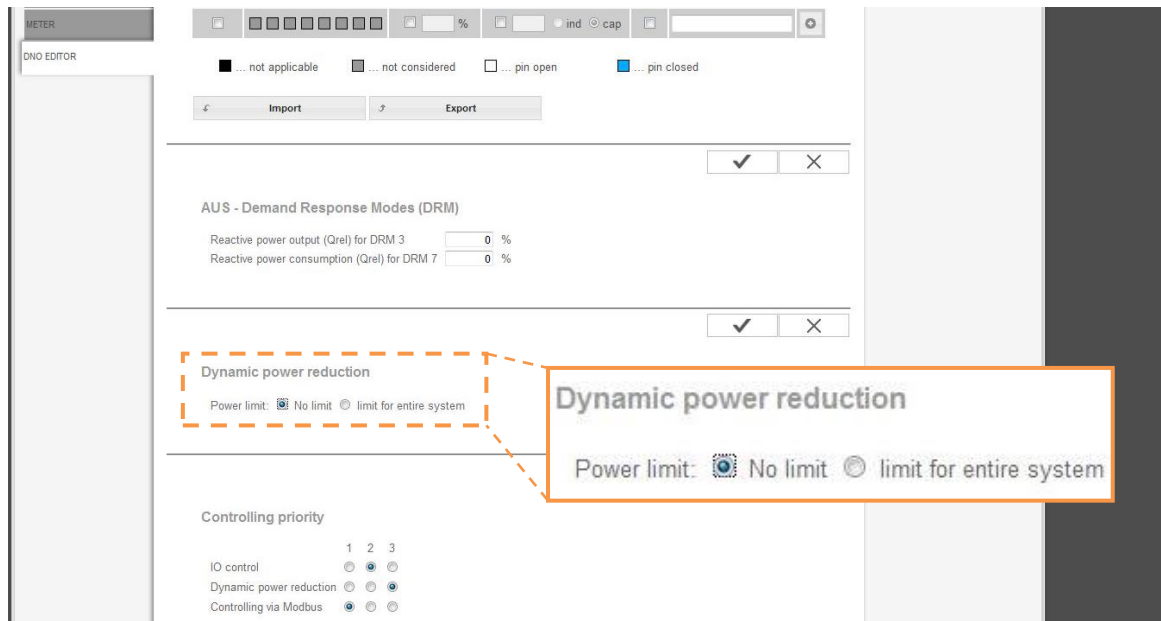

Check the Modbus settings – settings must be as below -

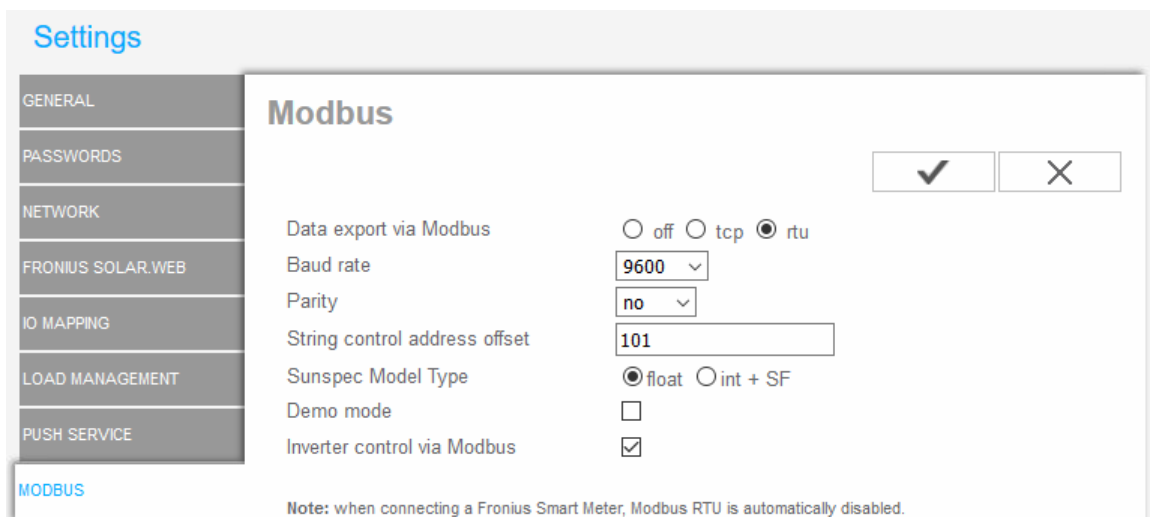

**The Fronius Smart Meter is now disabled and communication between the SP PRO and Fronius SCERT can be established.**

# SP PRO SCERT Fronius Primo or Symo Managed AC Coupling Installation Notes



## Appendix IV: Communications Link Configuration with "AC Coupled Interface PCA"

The communication link always starts at the SP PRO and links to the "AC Coupled Interface PCA", then connects to the first Fronius Primo (Master). The Fronius link is used to connect subsequent Fronius Primos on the same phase as the SP PRO. Do not connect Fronius Primos on different phases together.

To install the AC Coupled Interface PCA, remove the bottom two screws from the Expansion Card and replace them with the provided stand-offs. Mount the AC Coupled Interface PCA to the Expansion Card inside the SP PRO close to the Serial Communication PCA, and connect the connector with the two blue wires to socket J2 on the Expansion Card as illustrated.

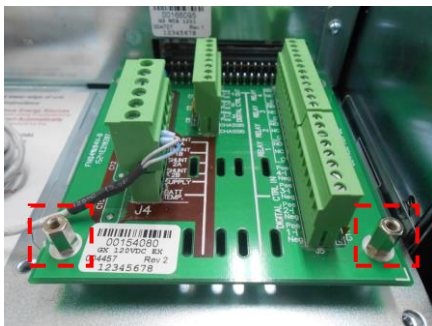

Expansion Card bottom screws replaced with stand offs.

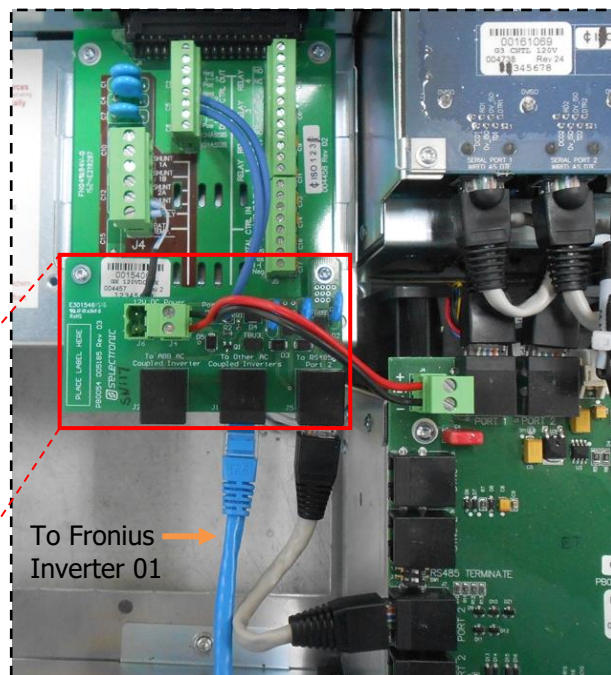
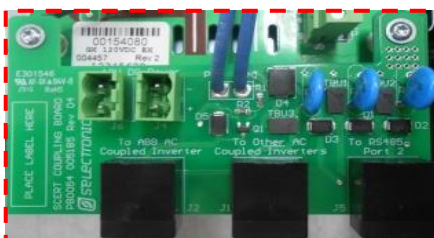

- Connect the RJ45 Connector lead from the AC Coupled Interface PCA "To RS485 Port 2" to the SP PRO Serial Communication PCA **RS485 Port 2**.
- Connect the second RJ45 lead from the AC Coupled Interface PCA "To Other AC Coupled Inverters" to Fronius Primo 01 (Master), Fronius Datamanger connector (see section "Fronius RS485 Connection to Inverter 01 (Master)" page 41).
- Connect the AC Coupled Interface PCA power loom (12V) from AC Coupled Interface PCA "**12V DC Power J4**" to the SP PRO Serial Communication PCA 12V connector.

**Note:** Do not connect any RJ45 leads to the AC Coupled Interface PCA "To ABB AC Coupled Inverter" connector as the pinout is different to the Fronius Primo connection.



# SP PRO SCERT Fronius Primo or Symo Managed AC Coupling Installation Notes



## Fronius Communication link to SP PRO Communication Card

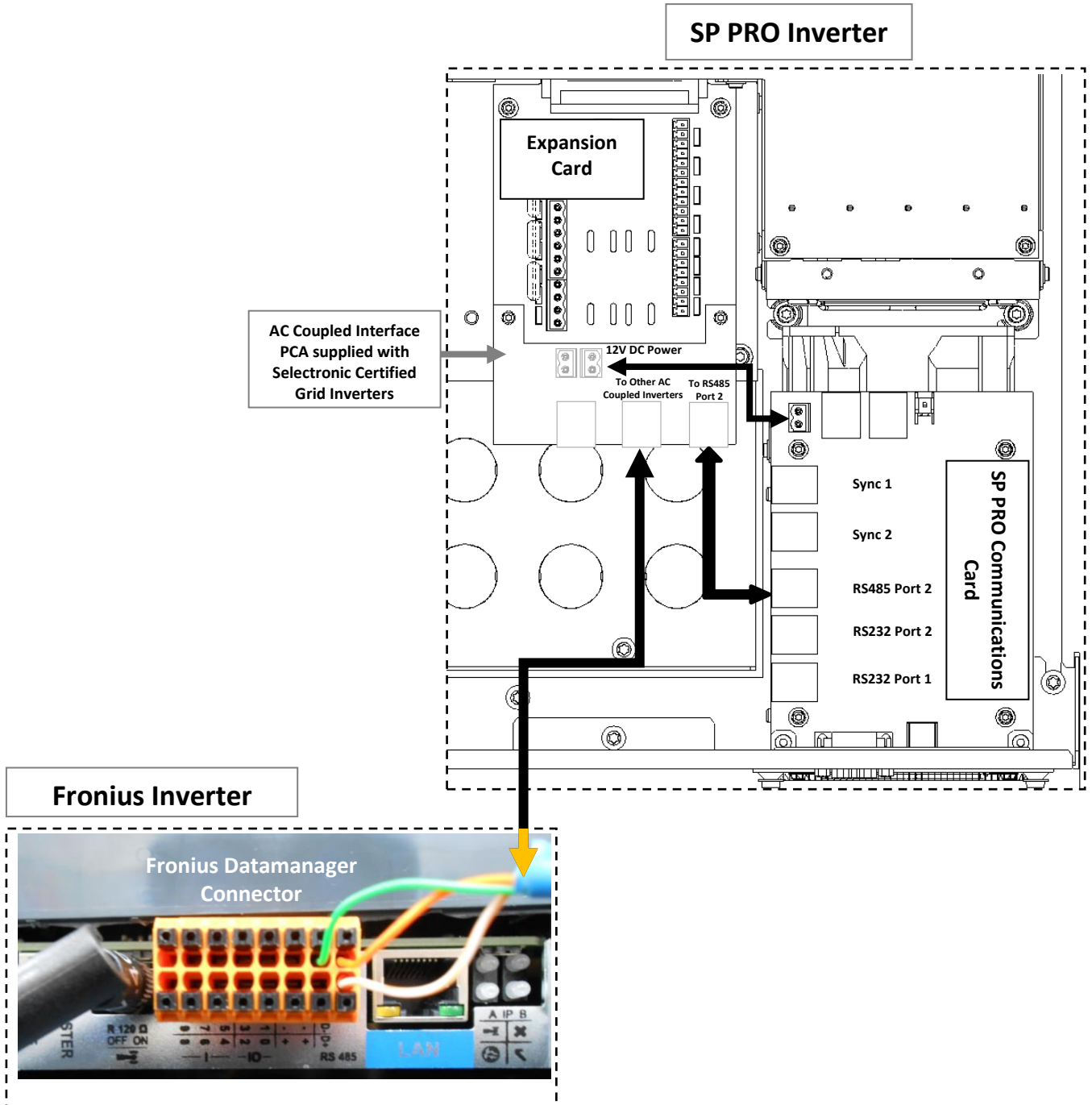

*SP PRO Connections (inside unit) – RS485 Port 2 RJ45 connector to AC Coupled Interface PCA and to Fronius Datamanager connector .*

# SP PRO SCERT Fronius Primo or Symo Managed AC Coupling Installation Notes



## RS485 Connection to First Fronius Primo (Master) – Series 2i and Series II

Using the supplied CAT5 network cable, connect one end to the AC Coupled Interface PCA **"To Other AC Coupled Inverters"** on the SP PRO. At Fronius Primo 01 (Master), **cut off the non-connected RJ45 connector**, expose and crimp the wires using wire crimps, or alternatively use a longer cable as required (not supplied) as outlined in the table below.

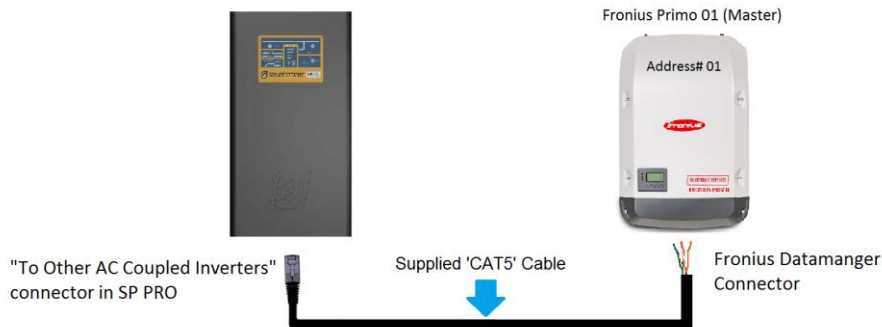

**The Fronius link is used to connect subsequent Fronius Primos on the same phase as the SP PRO. Do not connect Fronius Primos on different phases together.**

**NOTE:** There are two different colour coding for RJ45 plugs, **T568A** and **T568B**, it is common that either colour code is used. To ensure correct connections please check that the "RS485 RJ45 Adaptor pin #" (see below table) corresponds to the "Fronius RS485 Connector" connection by buzzing out the lead before connecting it to the Fronius Primo or the SP PRO.

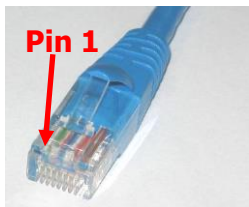

RS485 RJ45 Adaptor Pin 1 designation

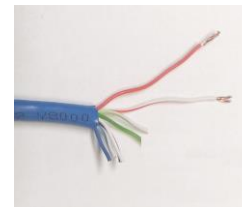

Cut off one RJ45 Connector (T568A colour code shown)

RS485 RJ45 Adaptor pin #	Signal	T568A colour code	T568B colour code	Fronius RS485 Connector
1	GND	Green/White	Orange/White	
2	GND	Green	Orange	- (minus)
3	RS485 - B	Orange/White	Green/White	D+ (RS485)
4	GND	Blue	Blue	
5	GND	Blue/White	Blue/White	
6	RS485 - A	Orange	Green	D- (RS485)
7	GND	Brown/White	Brown/White	
8	GND	Brown	Brown	

RS485 adaptor to Fronius Primo connections and wire colours

**Note:** Only the wires connected to Pins 2, 3 and 6 (on the RJ45) are used.

# SP PRO SCERT Fronius Primo or Symo Managed AC Coupling Installation Notes



## RS485 Communication to First Fronius Primo (RS485) – Series I

The communication link always starts at the SP PRO end via Coupling Adaptor (Sena LTC100) and then connects to the first Fronius Primo (Master). The Fronius Solar Net link is used to connect subsequent Fronius Primo inverters ON the same phase as the SP PRO.



To install the Coupling adapter, use the RJ45 to DB9 lead and connect the Coupling adapter to the SP PRO Series I **Serial Port 2**. Then using 'CAT5' network cable or similar make, connect the Coupling adaptor to Fronius Primo 01 (Master) as per Table 1, Fronius Datamanager connector.

Coupling Adaptor Connections	Signal	T568A colour code	T568B colour code	Fronius RS485 Connector
RX-	Not Used			
RX+	Not Used			
GND	Ground	Green	Orange	- (minus)
TX- / TRX-	RS485 - A	Orange	Green	D- (RS485)
TX+ / TRX+	RS485 - B	Orange/White	Green/White	D+ (RS485)

Table 1: Coupling Adaptor to Fronius connections and wire colours

**Note:** Ensure that the Sena LTC100 adaptor switch is set to RS485.

# SP PRO SCERT Fronius Primo or Symo Managed AC Coupling Installation Notes

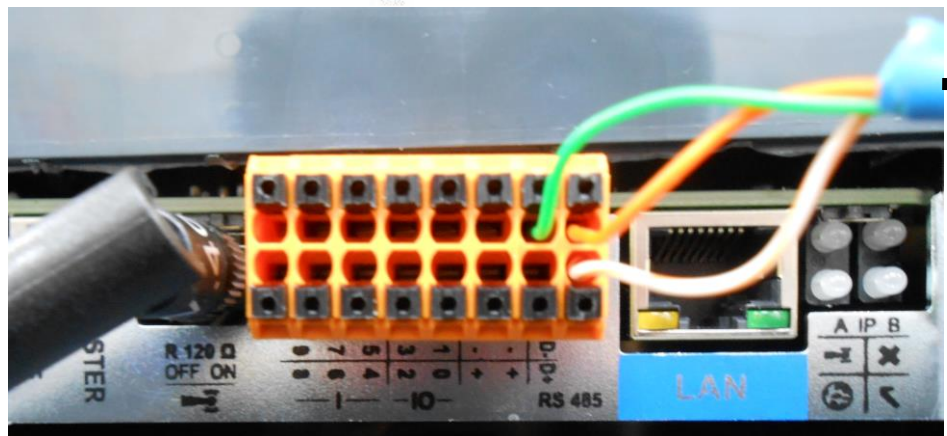
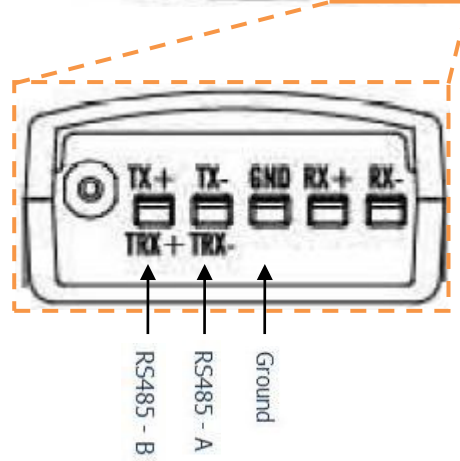
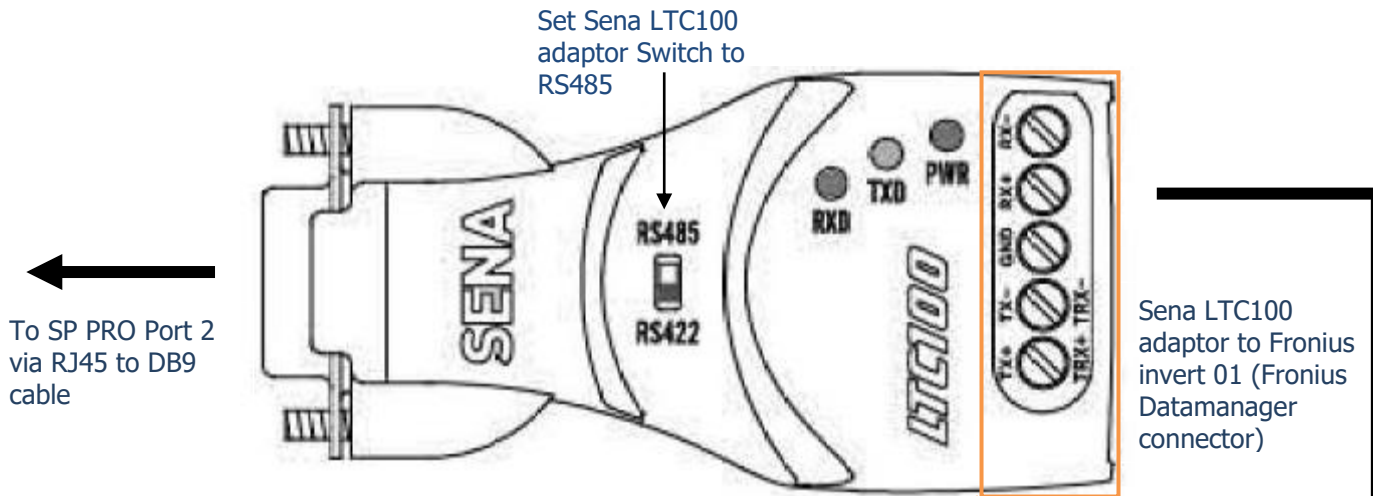

*SP PRO Port 2 RJ45 connector to Sena LTC100 and to Fronius Datamanager connector*

# SP PRO SCERT Fronius Primo or Symo Managed AC Coupling Installation Notes



## Appendix V: Fronius FailSafe Configuration

Each Fronius SCERT inverter must be set to Fail-Safe operation. Fail-Safe operation ensure that if the Solar Net connection faults, the Fronius units will revert to an off or fault state preventing un-controlled generation of power feeding into the managed SP PRO system.

Access the **PROFI** menu

*Note: Access to the Fronius "PROFI" menus is restricted via a code number. Contact Fronius for the "PROFI" menu access code.*

From the **PROFI** menu

Select **Fail-Safe**

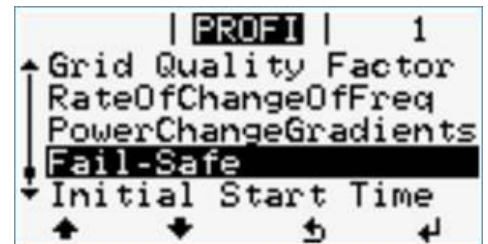

Select **DM FailSafe Mode**



Set to **Permanent**



Select **DM FailSafe Behaviour**

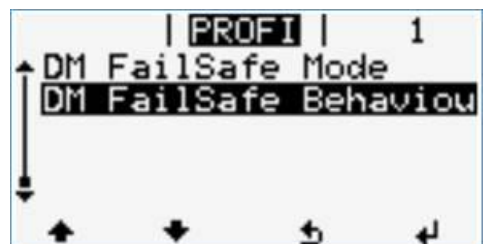

Set to **Disconn.**



# SP PRO SCERT Fronius Primo or Symo Managed AC Coupling Installation Notes



## Appendix VI: Fronius SCERT "Backup Ready" Connection

The following steps are for when Selectronic Certified SCERT Fronius units are installed without an SP PRO,

1. A **link** must be fitted to the orange "Fronius Datamanager Connector" from the "+" pin to IO "2" pin so that Fronius SCERTs can produce full power.

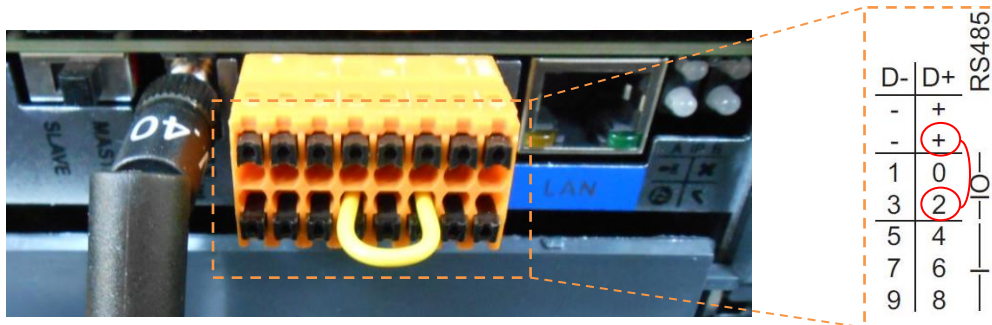

2. The country code must be set to AU – Australia



**Please note:** The link is only required when the SCERT inverter is installed without an SP PRO.